

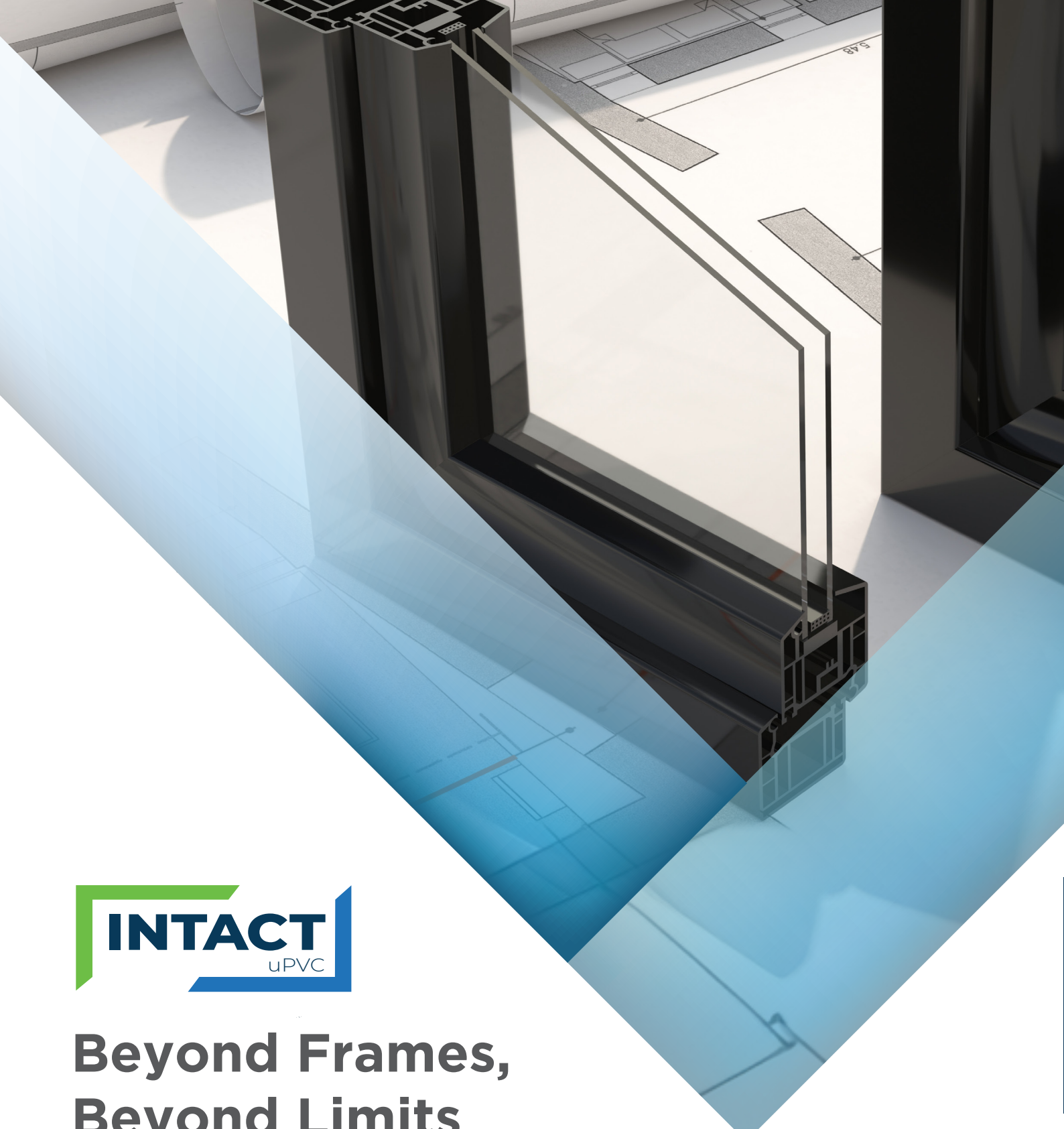

TECHNICAL CATALOGUE

Intact uPVC Profiles



Beyond Frames, Beyond Limits

Intact, a transformative force in the uPVC window and door sector, was established under the umbrella of a conglomerate with 35 years of extensive expertise in mining, steel, and plastic manufacturing. Our foundation rests upon a heritage of excellence, propelling Intact as the vanguard of uPVC innovations. With a legacy spanning decades, our brand epitomizes steadfast quality and reliability.

What truly sets us apart is our steadfast commitment not solely to delivering top-notch uPVC Window and Door solutions but also to championing sustainability. Leveraging the green energy sourced from our wind power project, we embrace eco-conscious practices, ensuring our products excel not only in quality but also in environmental responsibility.



Engineered for Life

At Intact, we blend durability and aesthetics seamlessly. Our customizable offerings boast a spectrum of textures, including captivating wood finishes, catering to the diverse preferences of our clientele. Trusted by discerning clients, our mission is to redefine living spaces by infusing them with a unique blend of style, colour, durability, and eco-friendliness. With a legacy of expertise and a commitment to sustainable innovation, Intact is poised to revolutionize the uPVC window and door sector, redefining standards and enriching spaces worldwide.

Area
60,000
Sft

Capacity
7,500 MT
per Year

Team
100

Our product testing process is meticulous and thorough. We subject each item to stringent assessments to ensure they meet the highest standards of quality, durability, and performance. This rigorous testing regimen is our assurance of delivering excellence.

- Hot Air Oven
- Ultra-Low Deep Freezer & Ball Drop Impact Tester
- Izod-Charpy Impact Test
- Advanced Spectrophotometer
- Digital Moisture
- Ultra-Modern Digital Density tester

INTACT ULTIMA



Dark Oak



Golden Oak

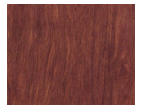

Mahogany



Grey



Black

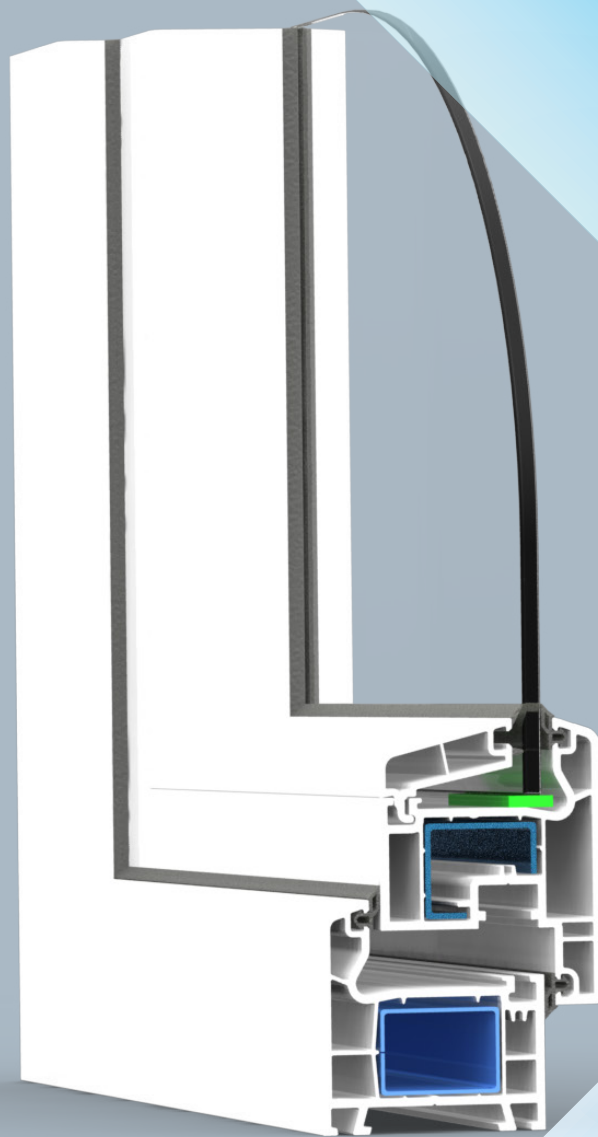

Casement Series

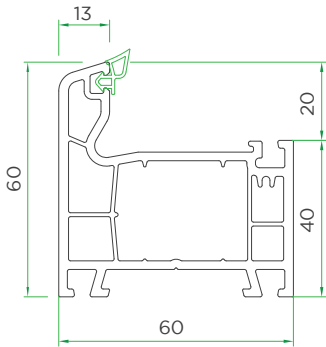

Casement Frame
VVI260-2010

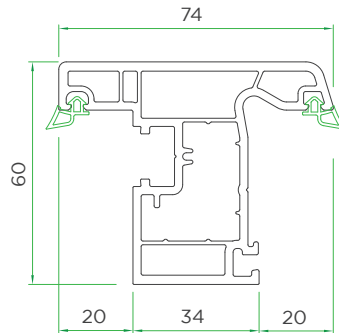

Casement Window Sash
VVI260-1020

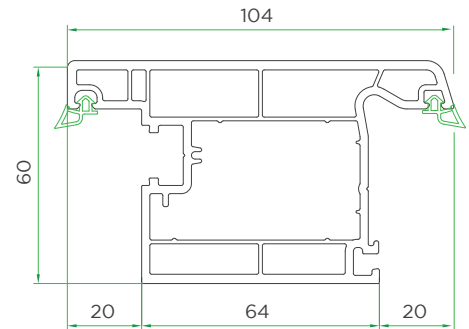

Casement Door Sash
VVI260-1030

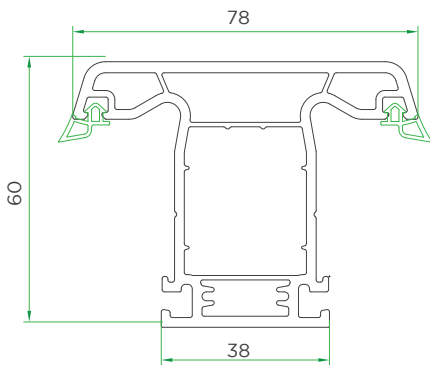

Casement Mullion
VVI260-2040

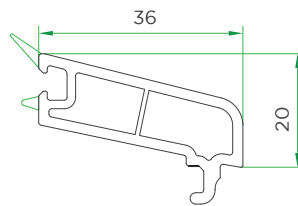

Single glazing bead-5mm
VVI260-0050

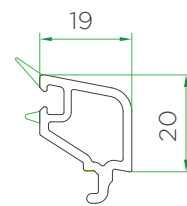

Double glazing bead-22mm
VVI260-0060

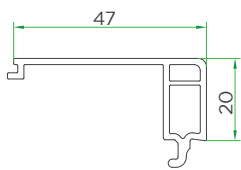

Louver Bead
VVI260-0070

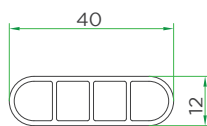

Louver Blade
VVI260-0080

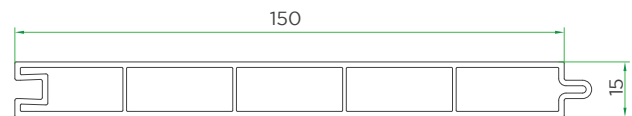

Panel Profile
VVI260-090



Frame Coupler
VVI260-0100

INTACT ULTIMA

Single Panel Casement Door

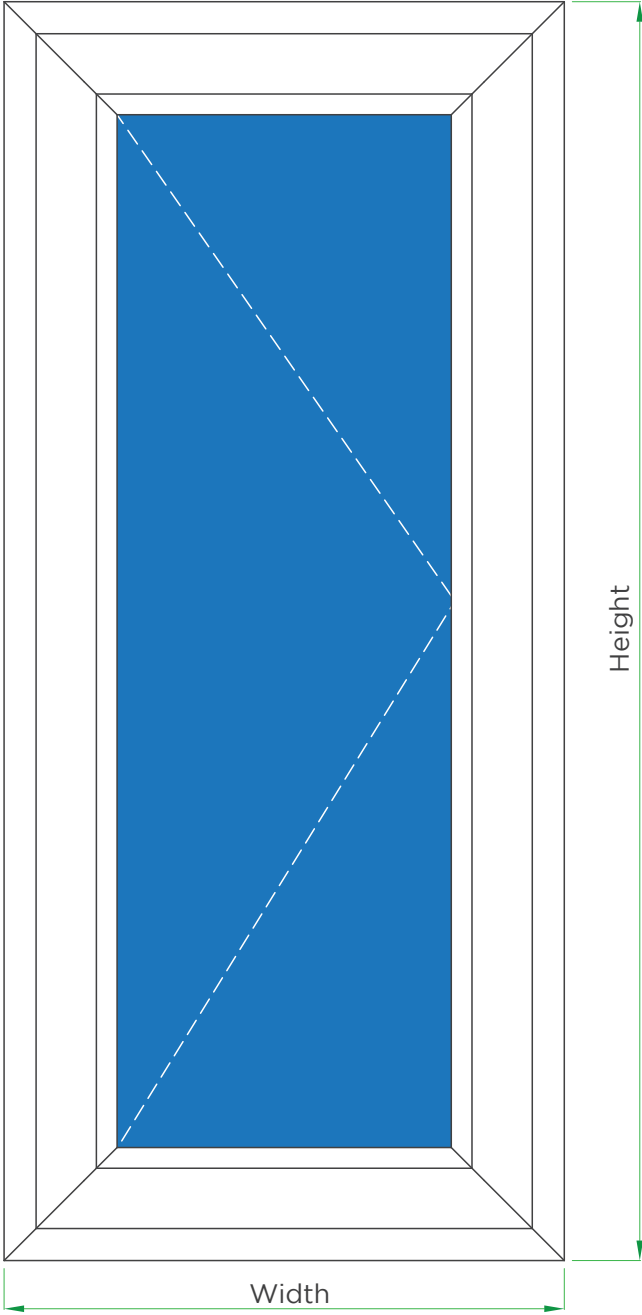

Elevation

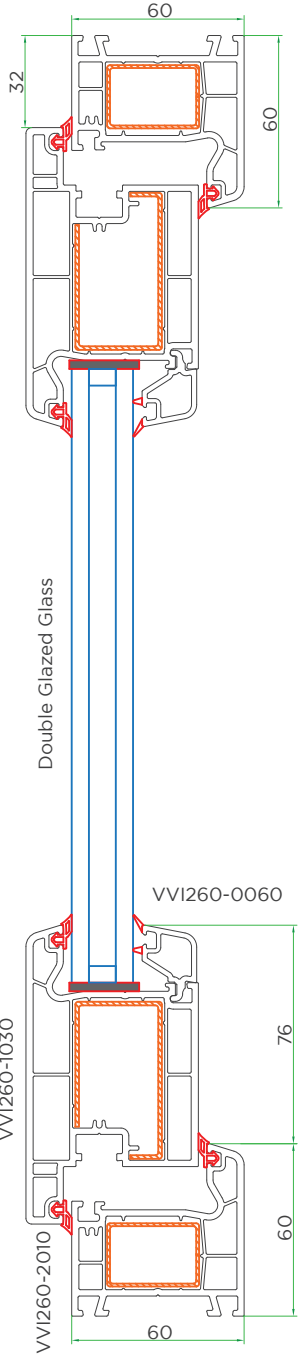

Cross sectional view-1

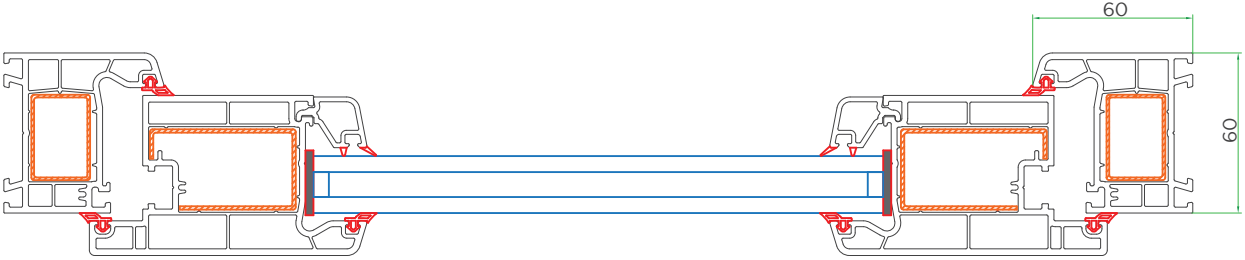

Cross sectional view-2

INTACT ULTIMA

Double Panel Casement Window

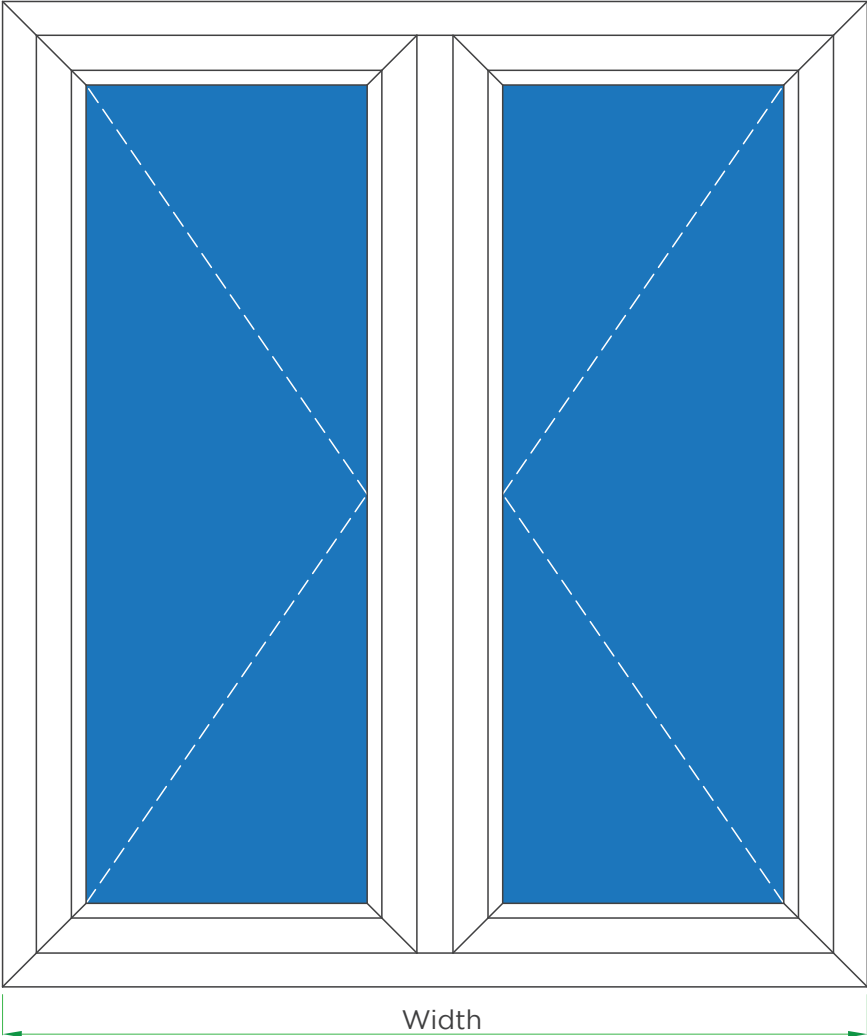

Elevation

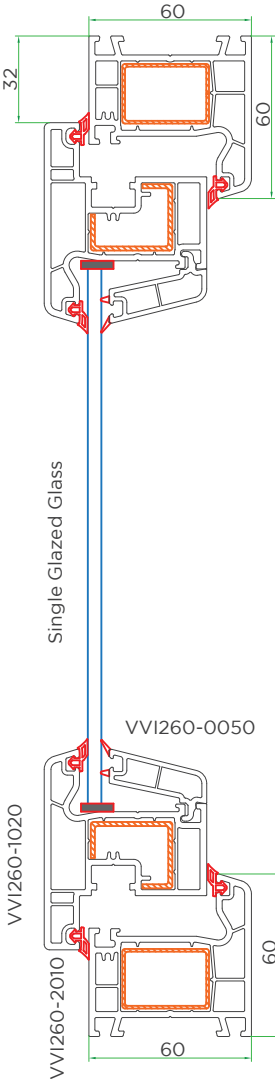

Cross sectional view-1

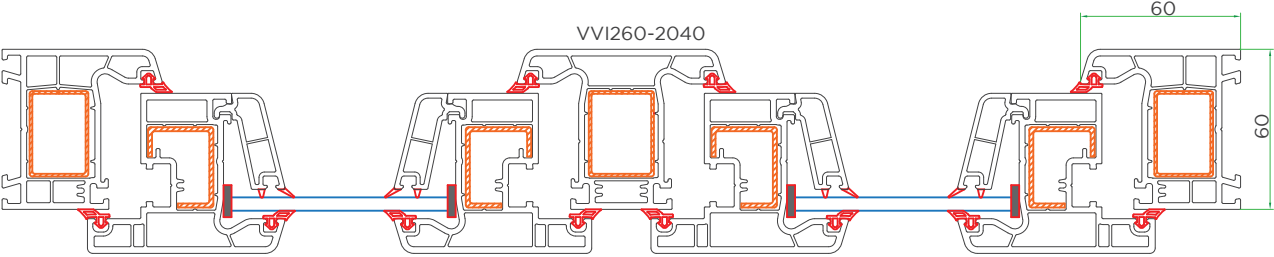

Cross sectional view-2

INTACT ULTIMA

Single Panel Casement Door

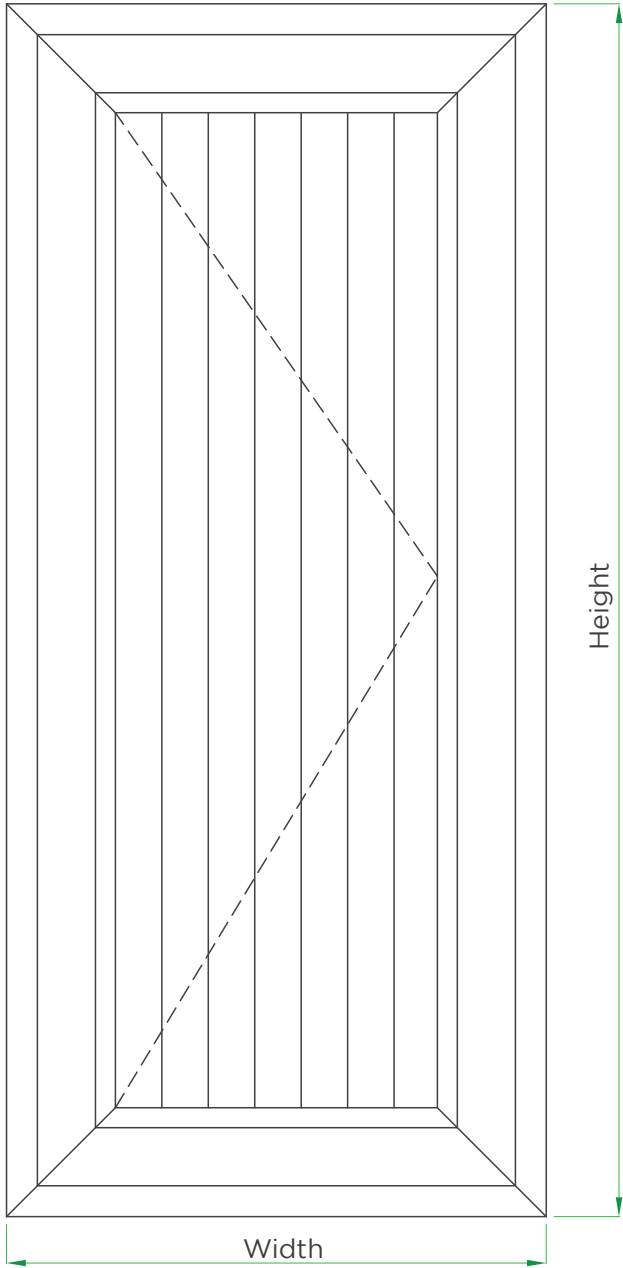

Elevation

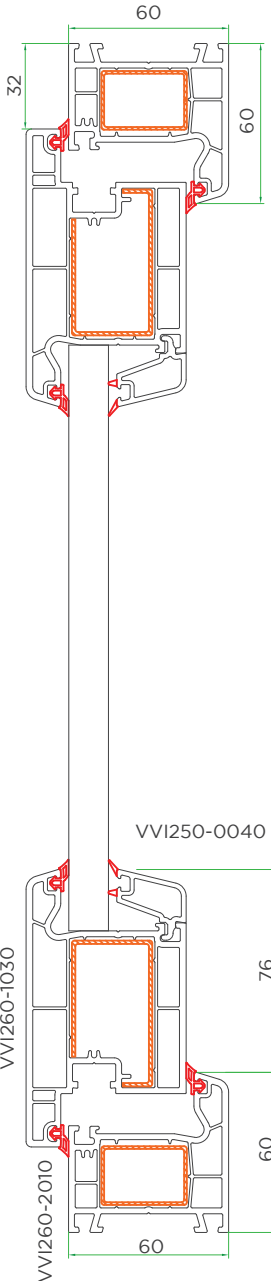

Cross sectional view-1

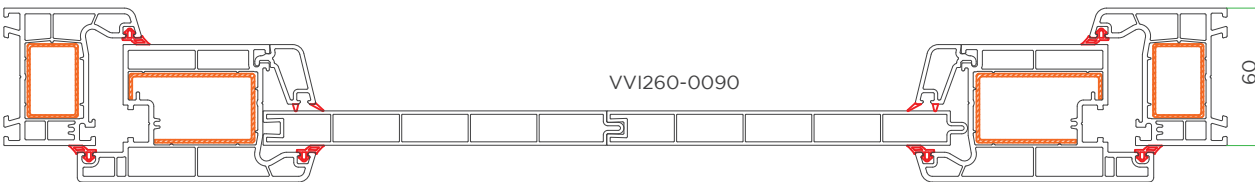

Cross sectional view-2

INTACT ULTIMA

Top Hung Window

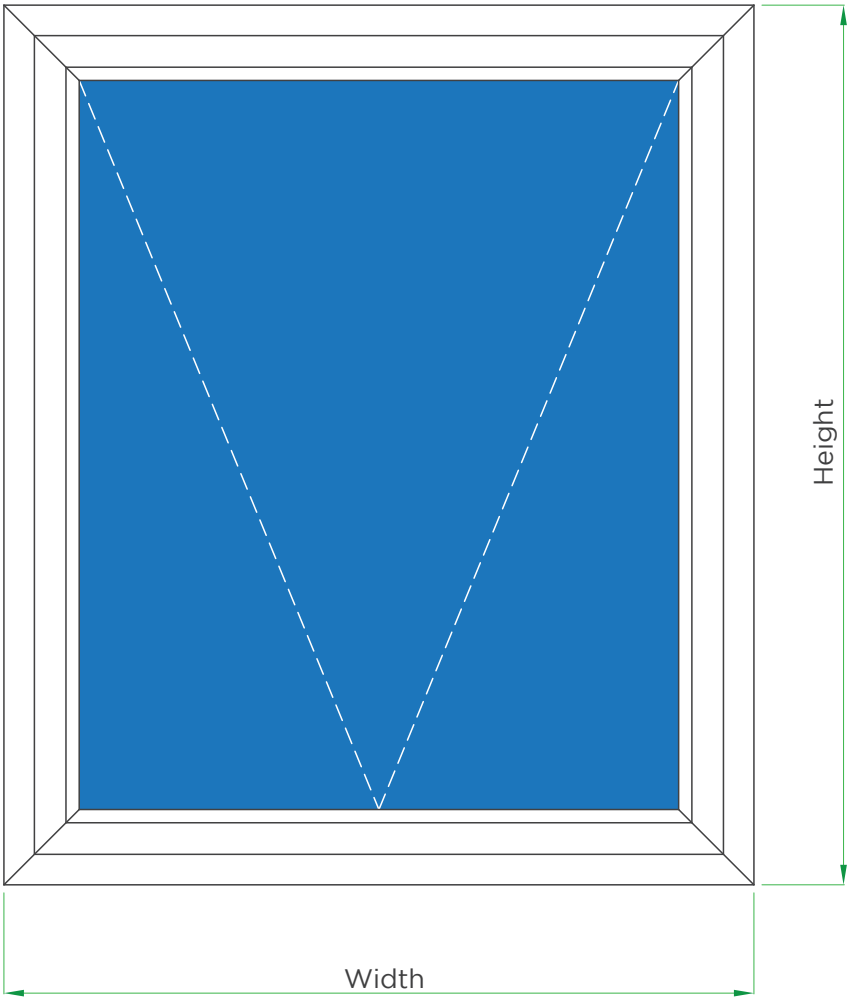

Elevation

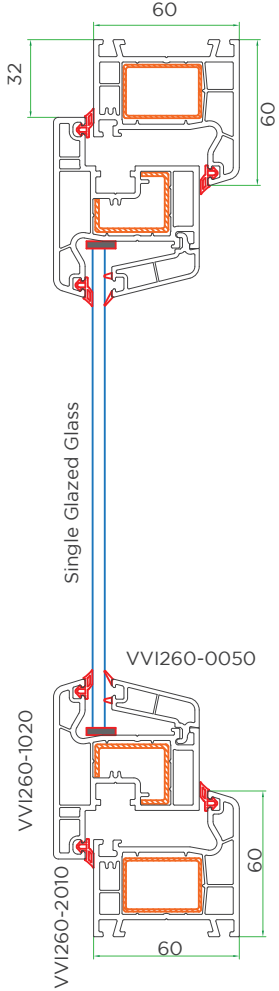

Cross sectional view-1



Cross sectional view-2

INTACT ULTIMA

Louver Window

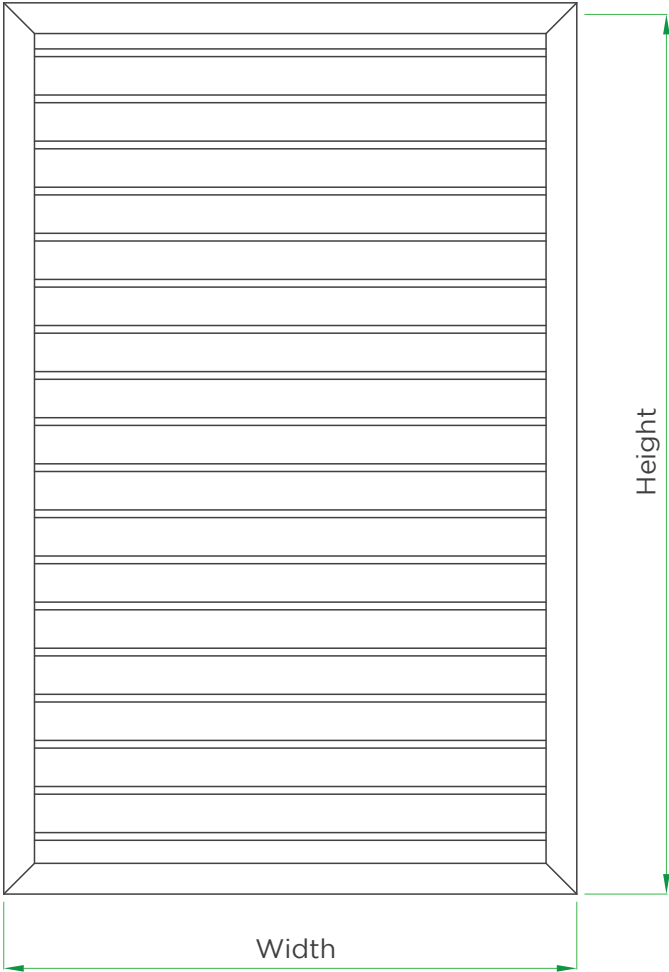

Elevation

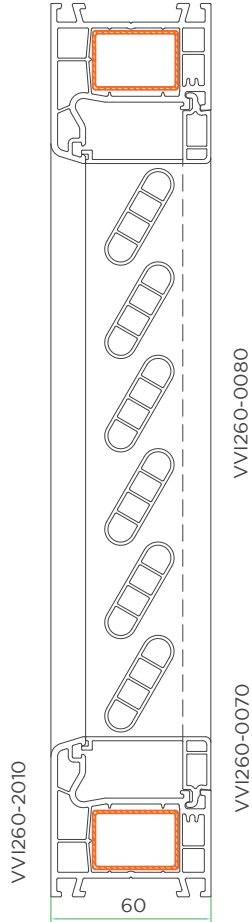

Cross sectional view-1

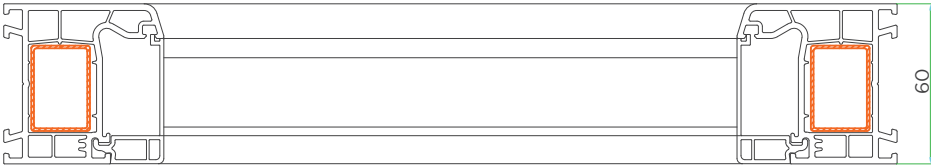

Cross sectional view-2

INTACT ULTIMA

2 Track 2 Panel Sliding window with Top fixed

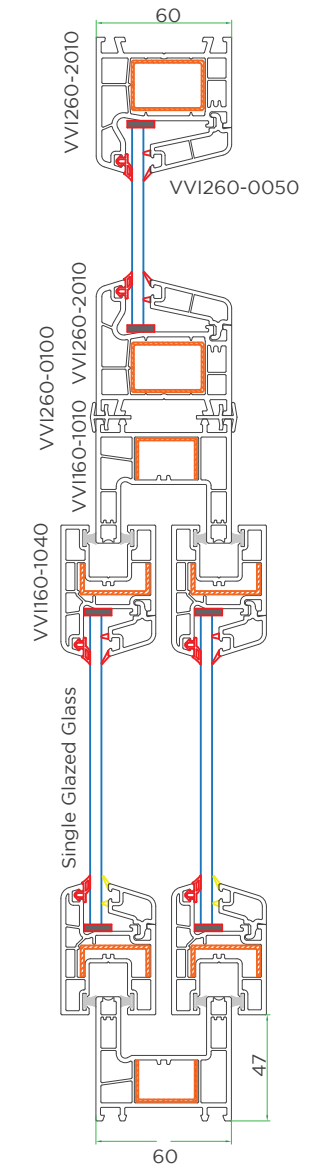
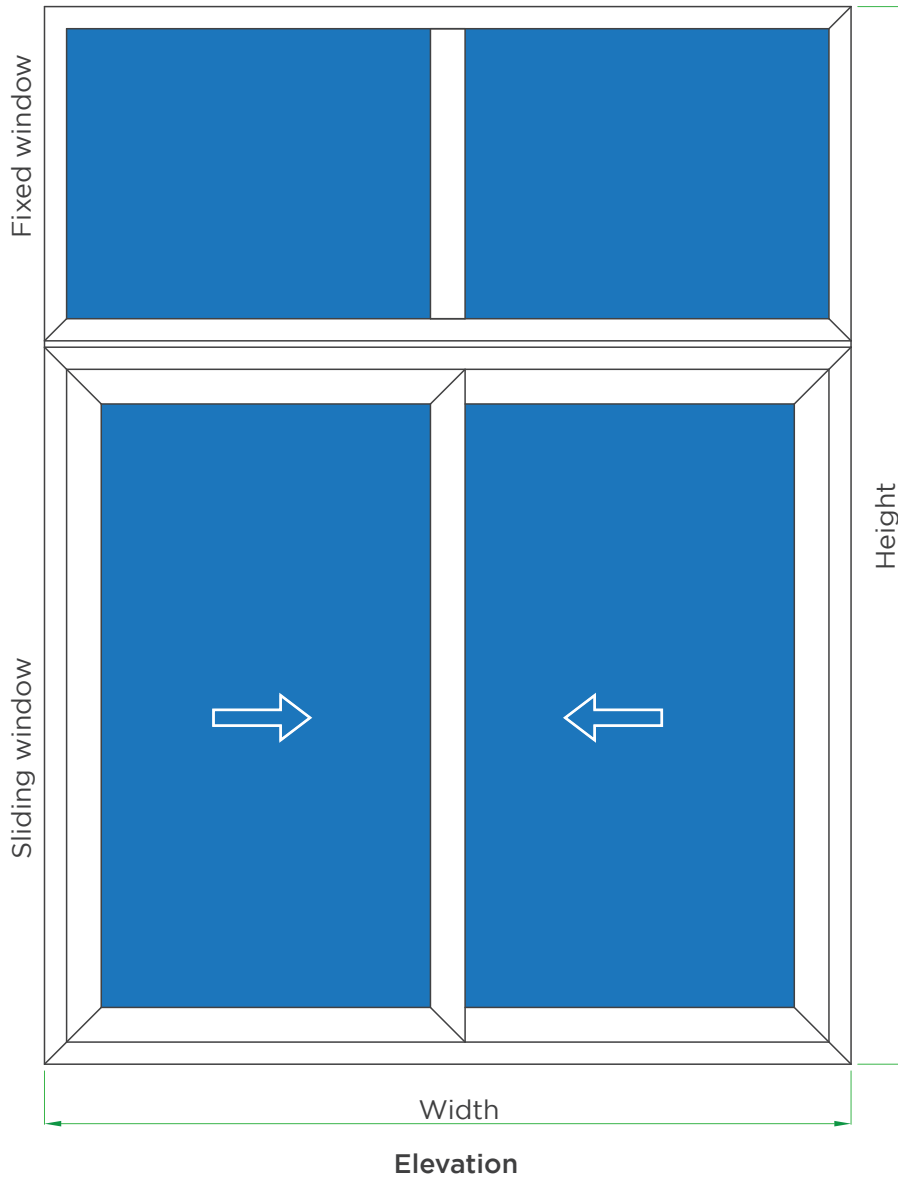

INTACT ULTIMA



Dark Oak



Golden Oak

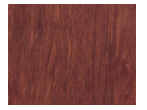

Mahogany

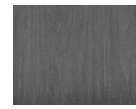

Grey



Black

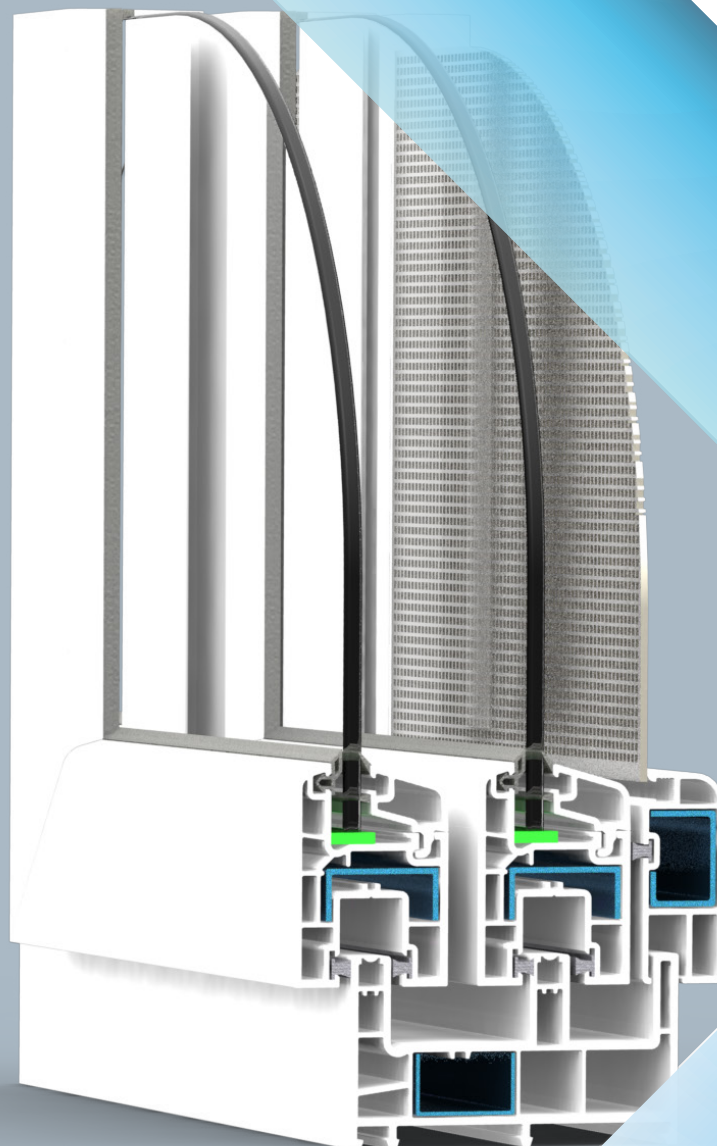

Sliding Series

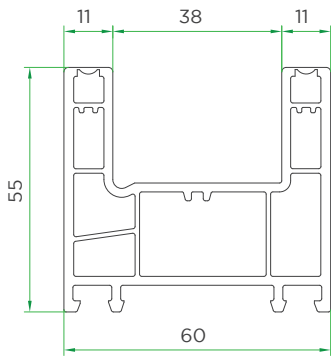

Sliding 2-track frame
VVI160-1010

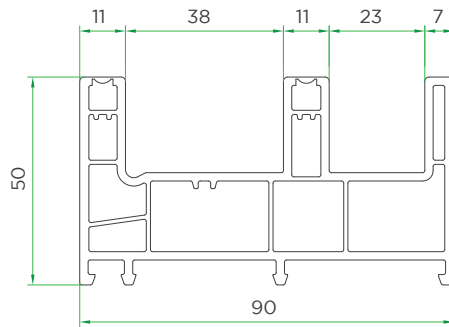

Sliding 2.5-track frame
VVI160-1020

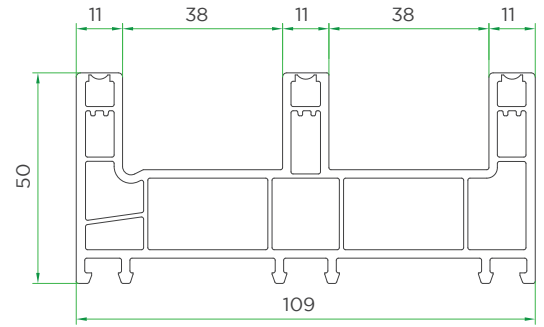

Sliding 3-track frame
VVI160-1030

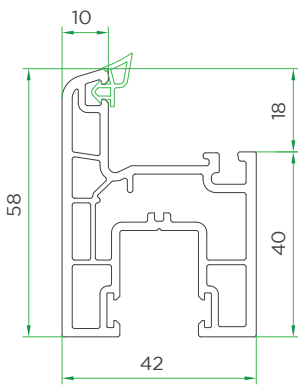

Sliding Sash
VVI160-1040

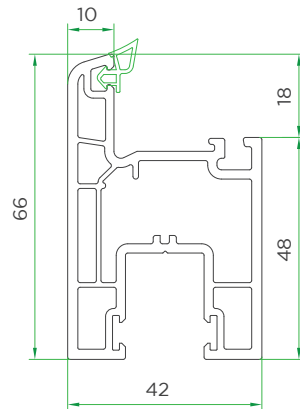

Sliding door sash
VVI160-1050

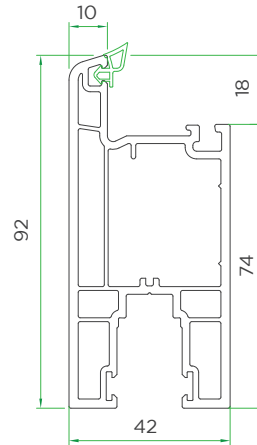

Sliding big door sash
VVI160-1060

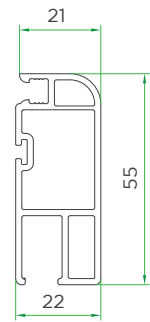

Mesh Sash profile
VVI160-1080

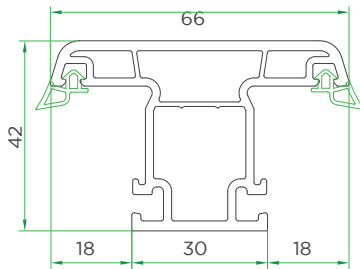

Sliding Mullion
VVI160-1070

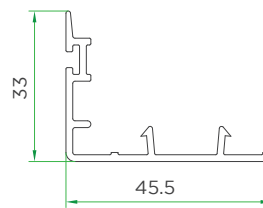

Sliding Sash Interlock
VVI160-0090

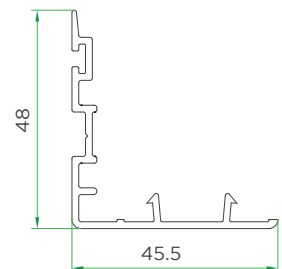

Sliding big door
Sash Interlock
VVI160-0100

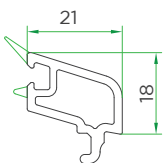

Single Glazing
Bead(5mm)
VVI160-0110

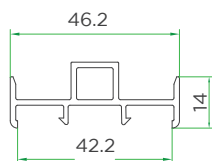

Sliding Sash
Connector
VVI160-0120

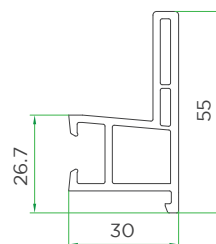

Add on Track
VVI160-0130

INTACT ULTIMA

2 Track 2 Panel Sliding window

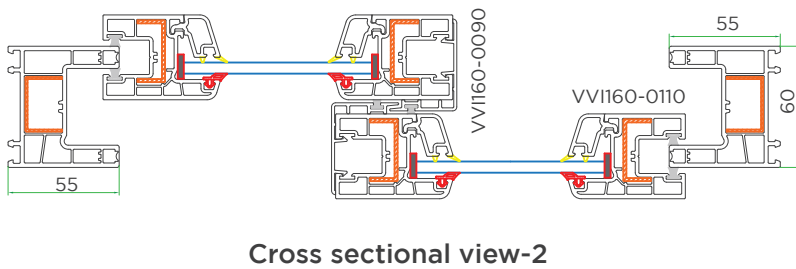
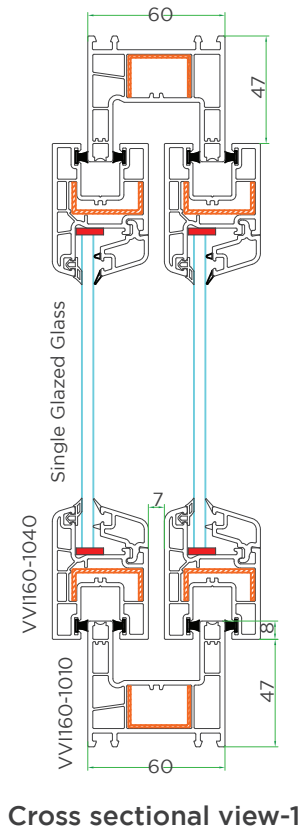
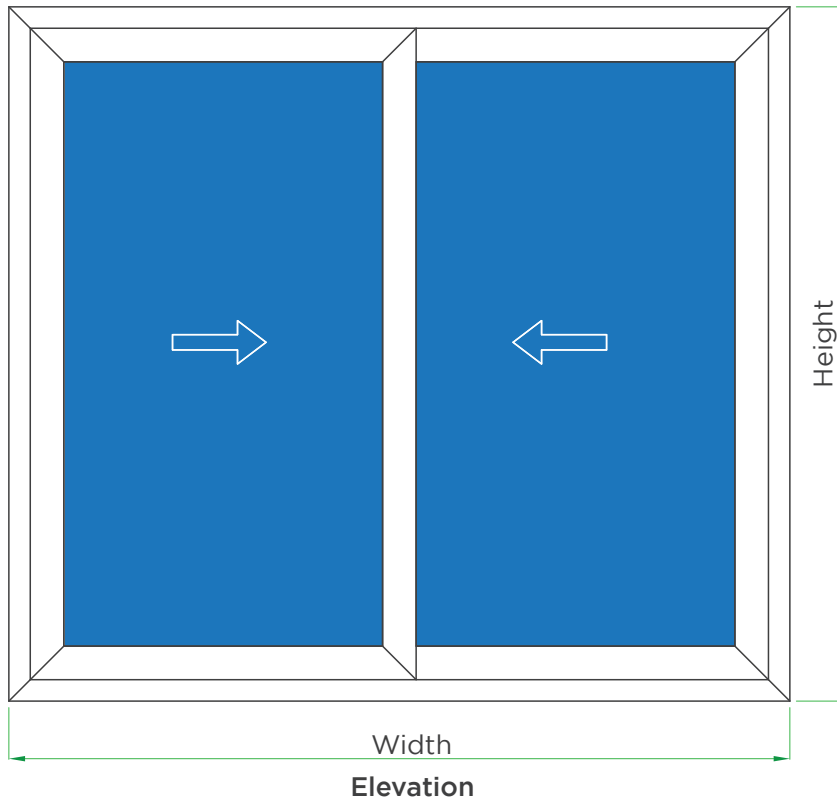

INTACT ULTIMA

2 Track 2 Panel Sliding window with mesh

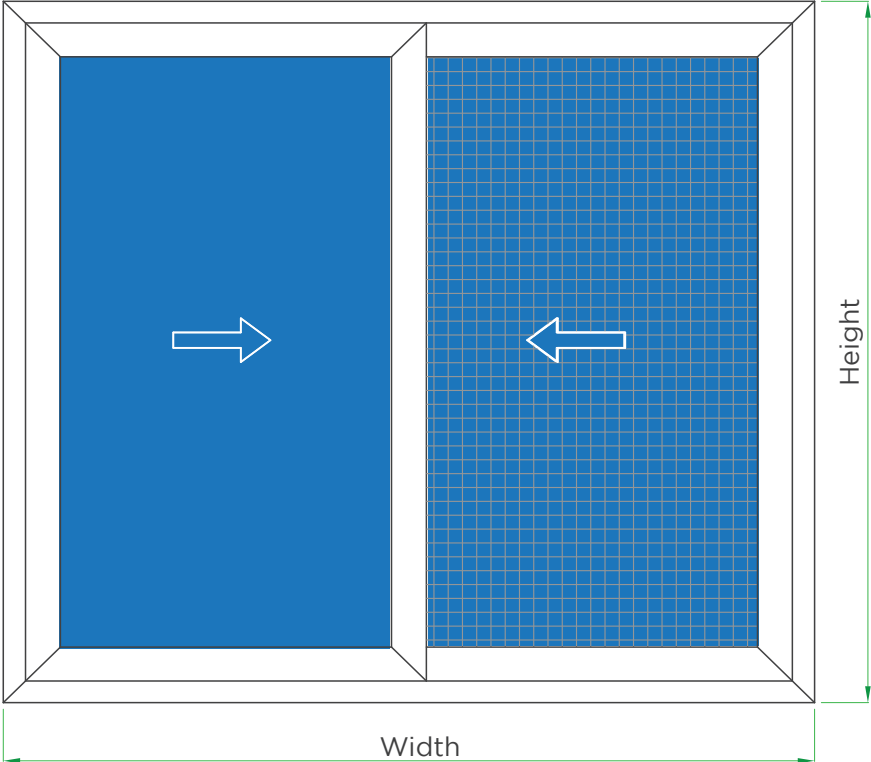

Elevation

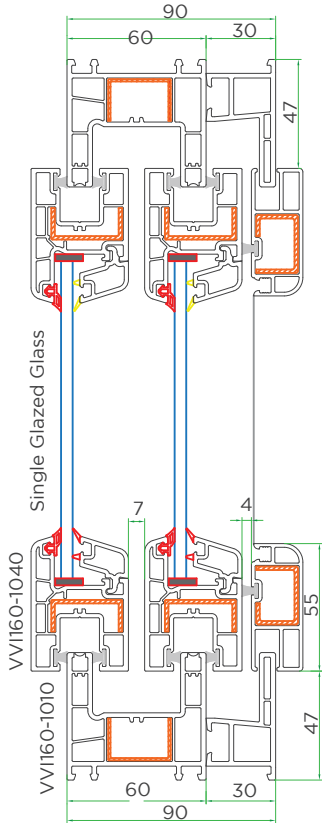

Cross sectional view-1

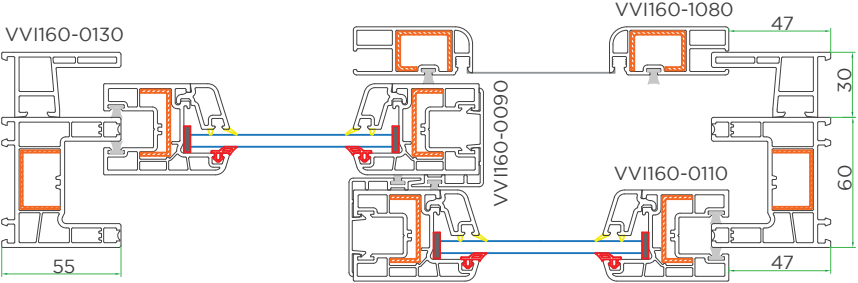

Cross sectional view-2

INTACT ULTIMA

2.5 Track 2 Panel Sliding window with mesh

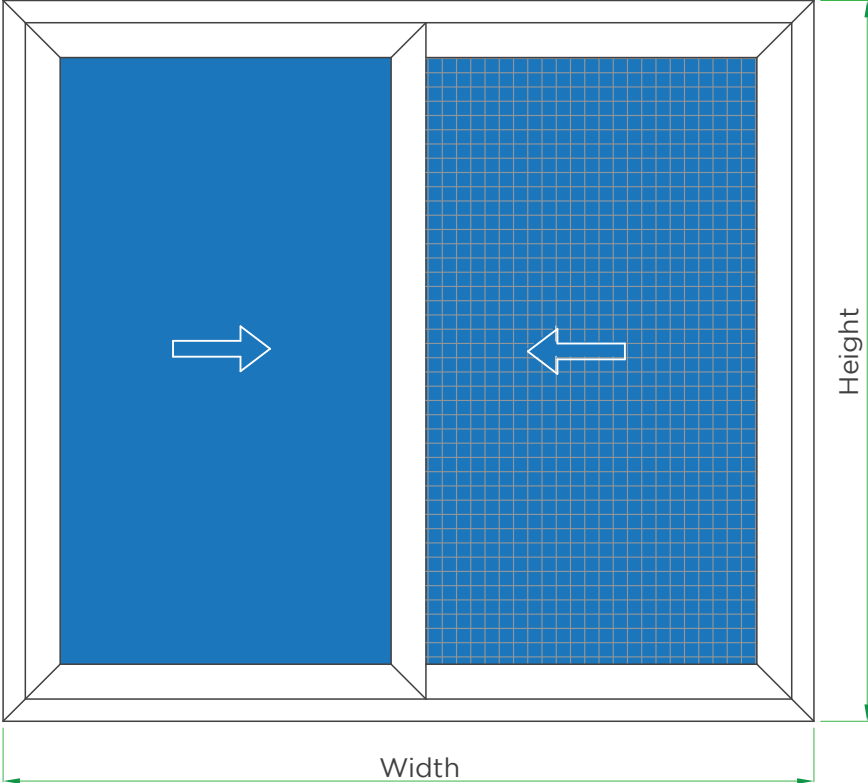

Elevation

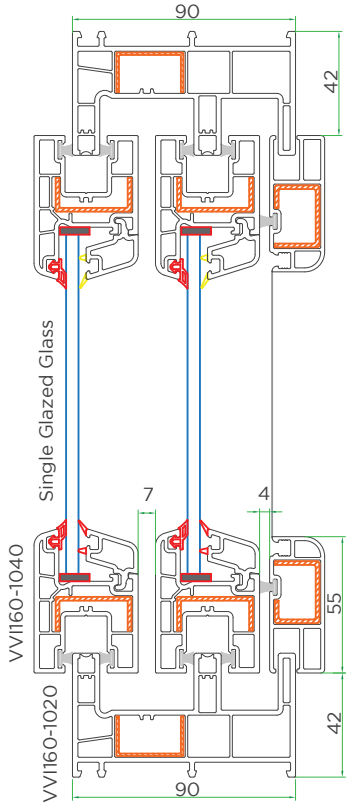

Cross sectional view-1

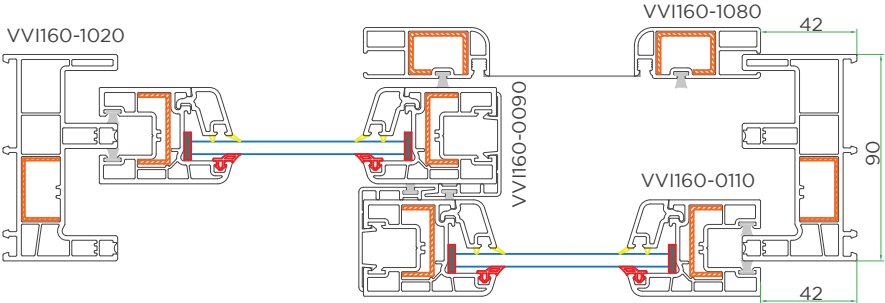

Cross sectional view-2

INTACT ULTIMA

3 Track 2 Panel Sliding Door

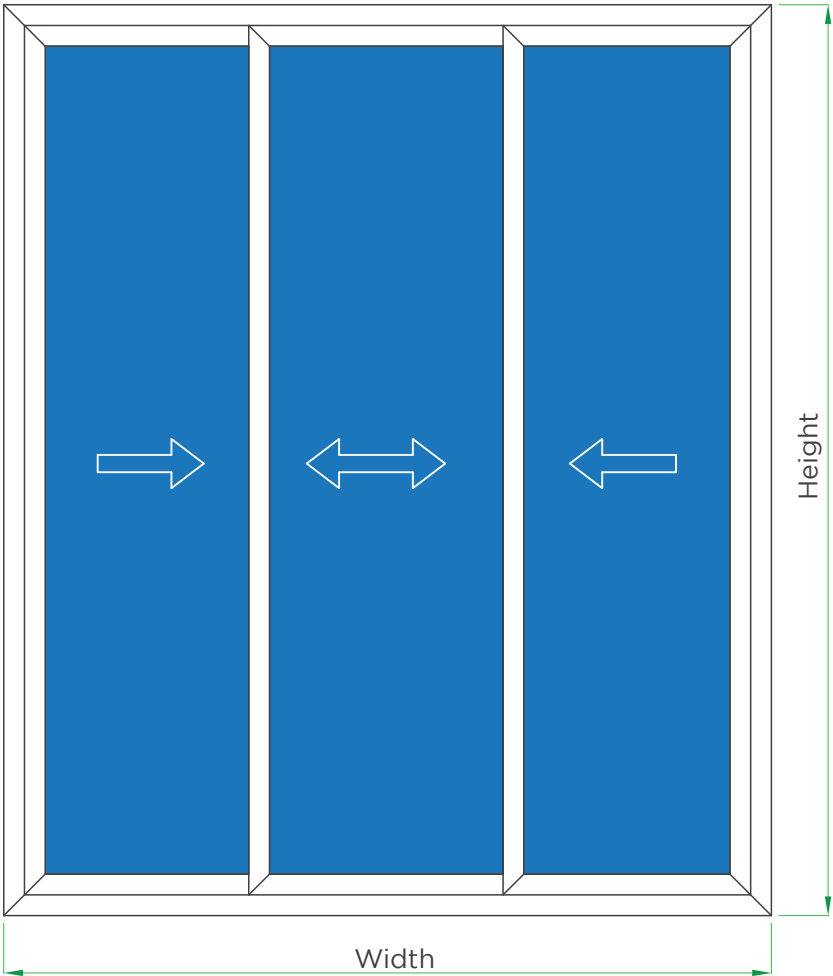

Elevation

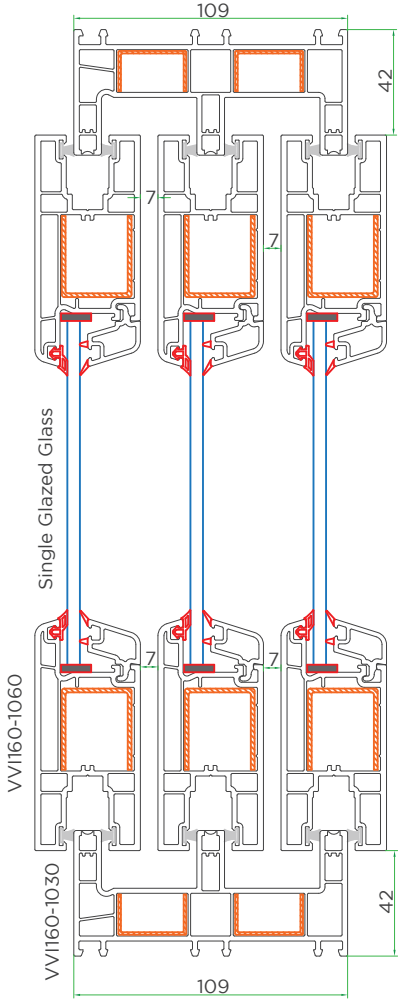

Cross sectional view-1

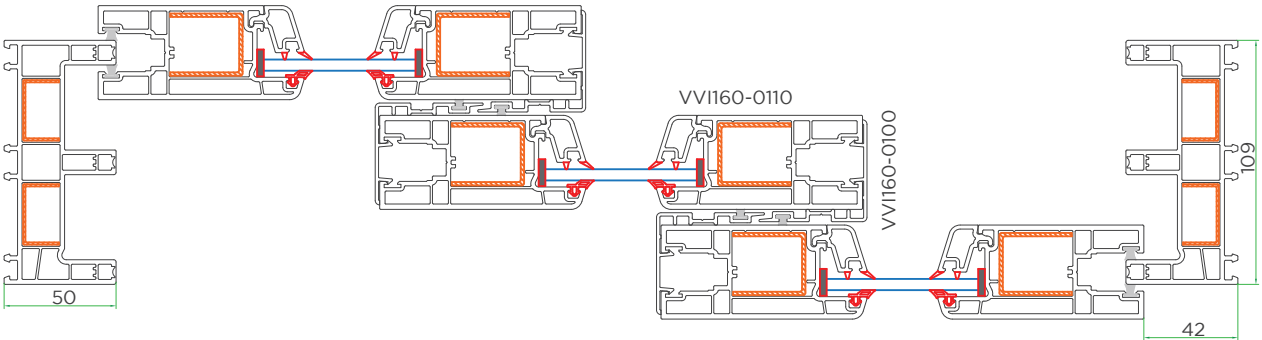

Cross sectional view-2

INTACT ULTIMA

2.5 Track 2 Panel Sliding window with Top fixed

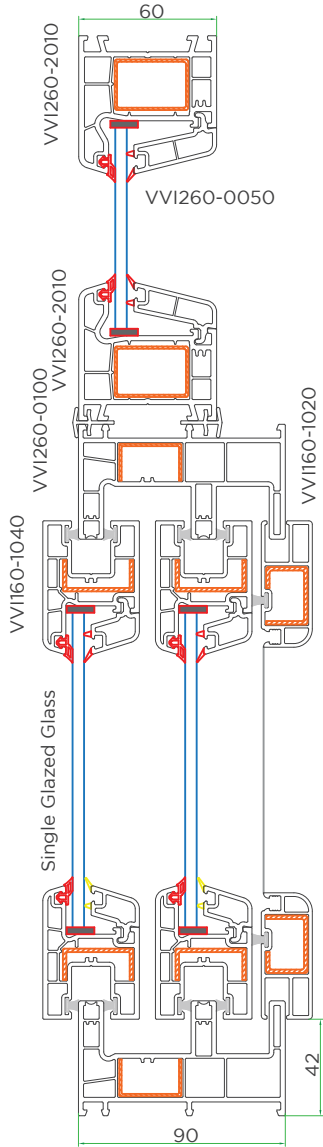
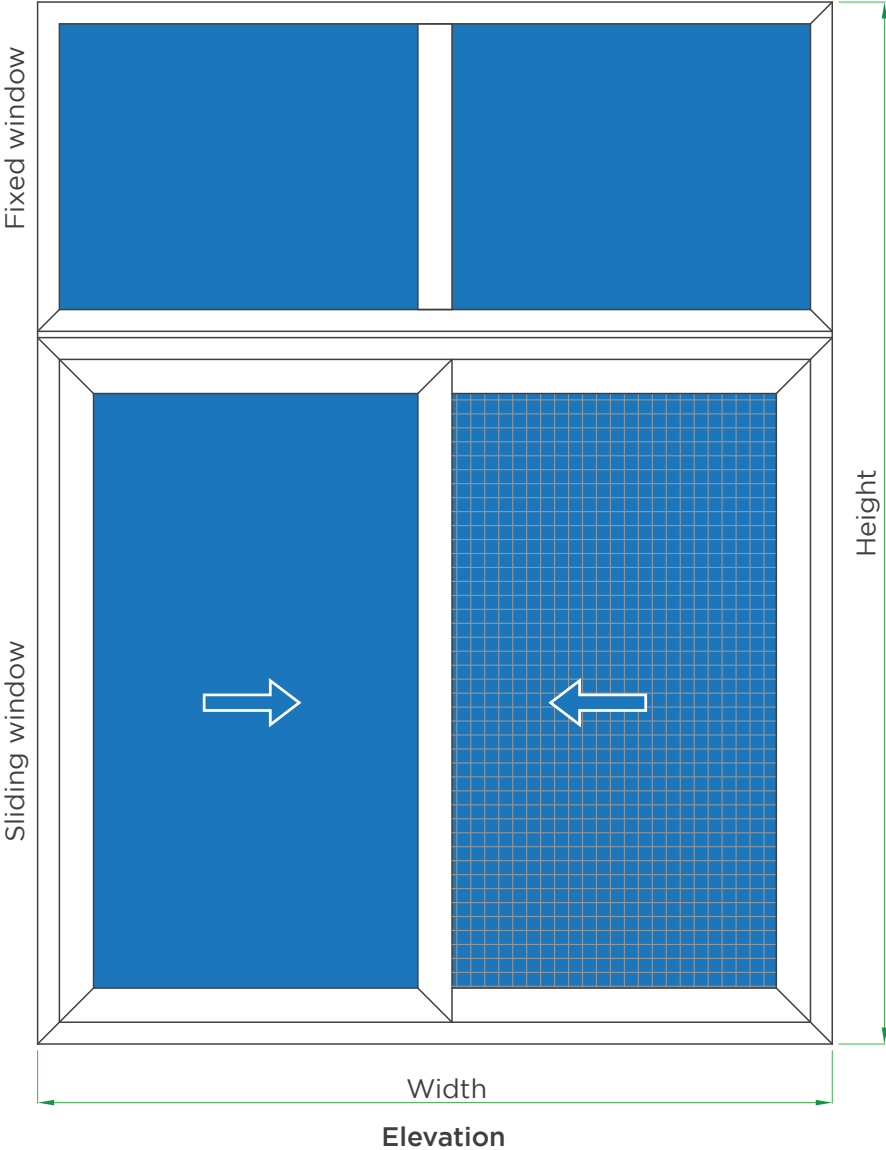

Cross sectional view-1

INTACT ULTIMA

2 Track 2 Panel Sliding window with Top fixed

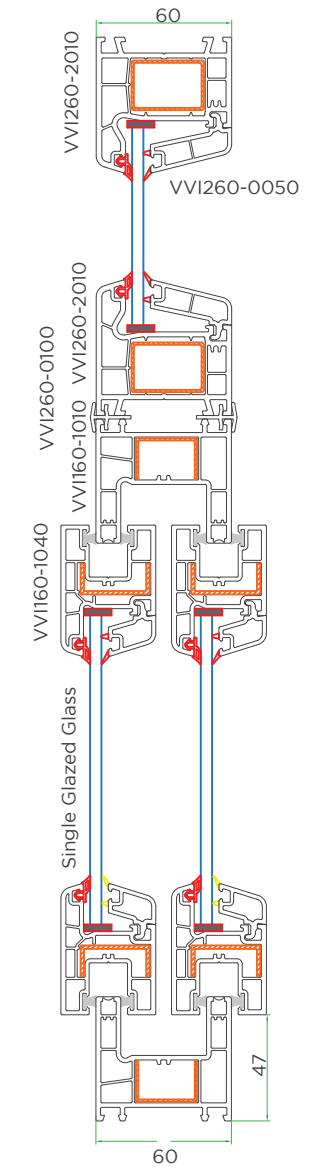
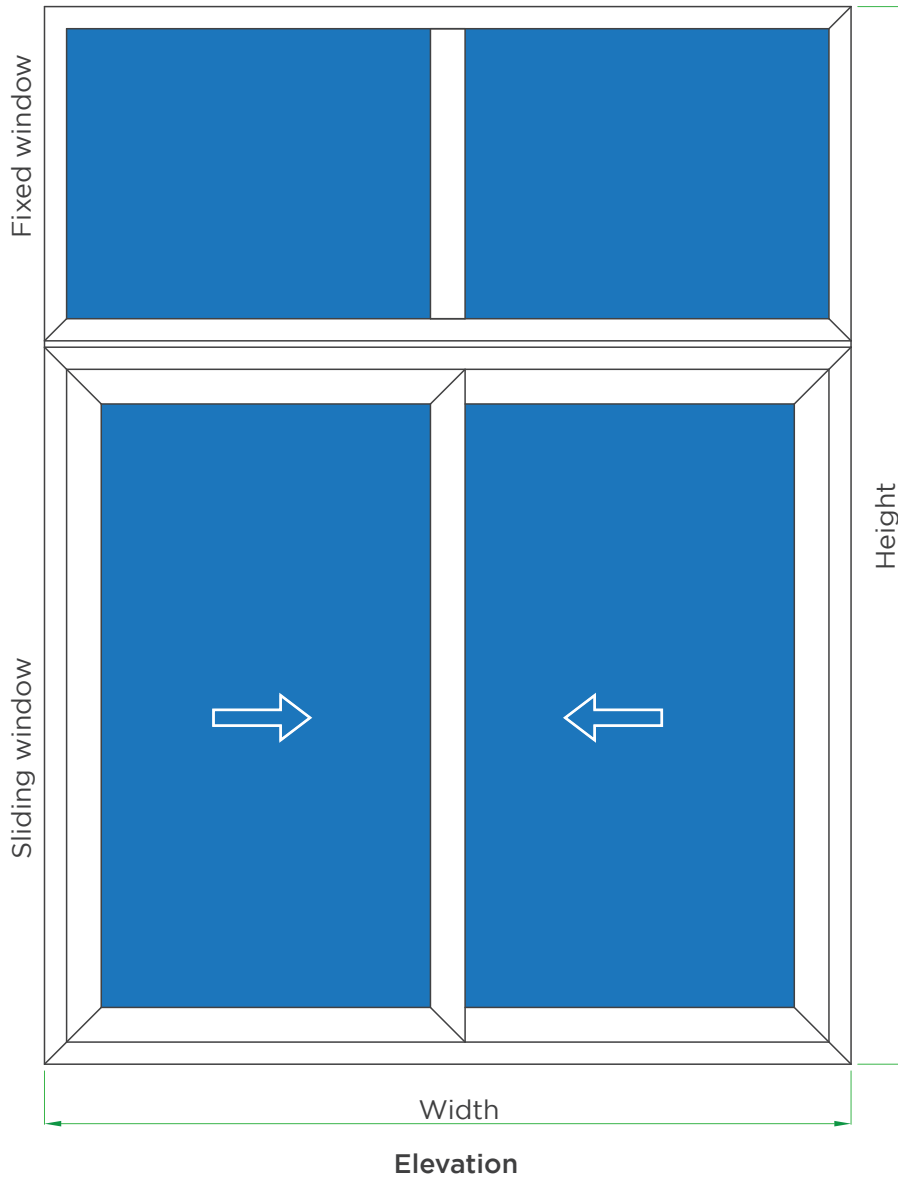

Cross sectional view-1

INTACT PRAGMA



Dark Oak



Golden Oak

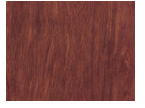

Mahogany



Grey



Black

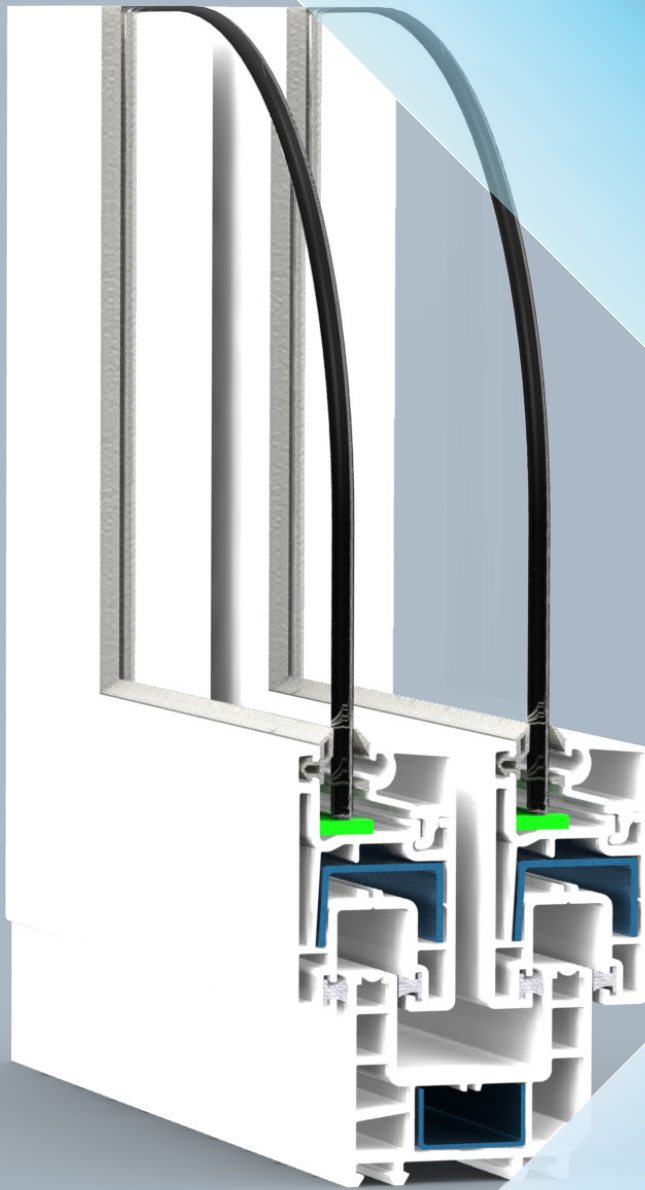

Casement Series

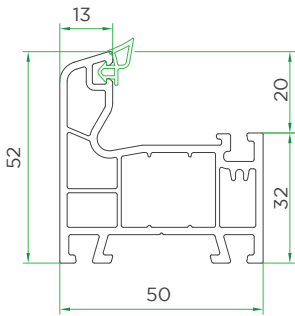

Casement Frame
VVI250-2010

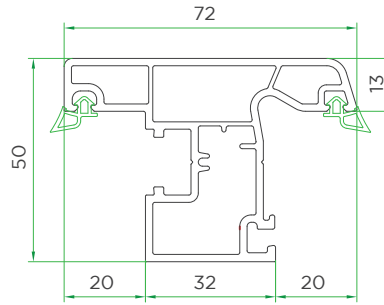

Casement Sash
VVI250-1020

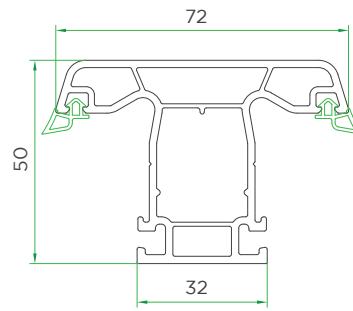

Casement Mullion
VVI250-2030

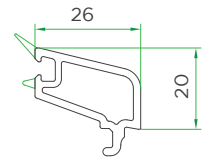

Single glazing
bead (5mm)
VVI250-0040

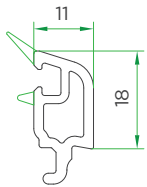

Double glazing bead (20mm)
VVI250-0050

Sliding Series

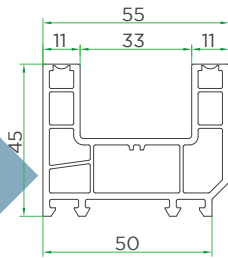

Sliding 2-track frame
VVI155-1010

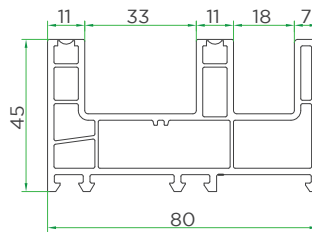

Sliding 2.5-track frame
VVI155-1020

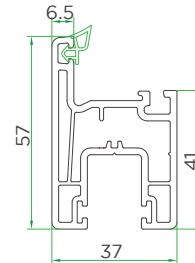

Sliding Sash
VVI155-1030

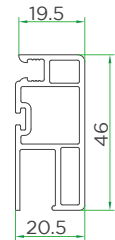

Mesh Sash
VVI155-1040

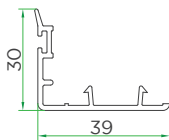

Sash Interlock
VVI155-0050

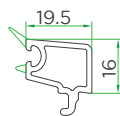

Single Glazing Bead (5mm)
VVI155-0060

INTACT PRAGMA

2 Track 2 Panel Sliding Window

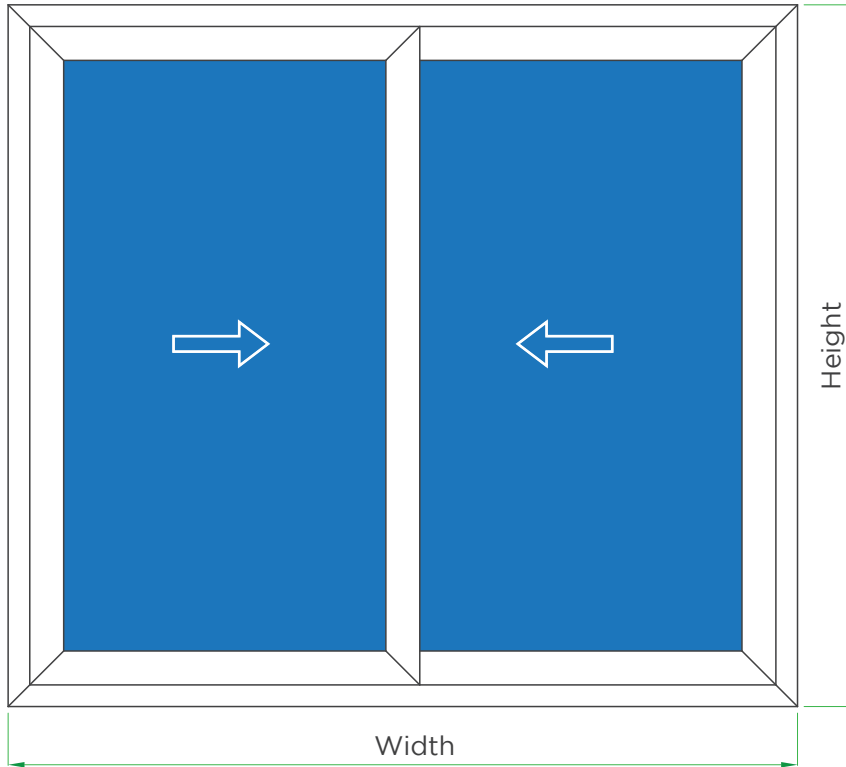

Elevation

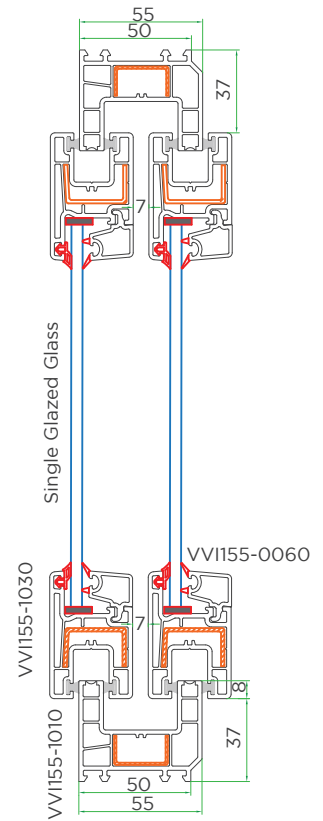

Cross sectional view-1

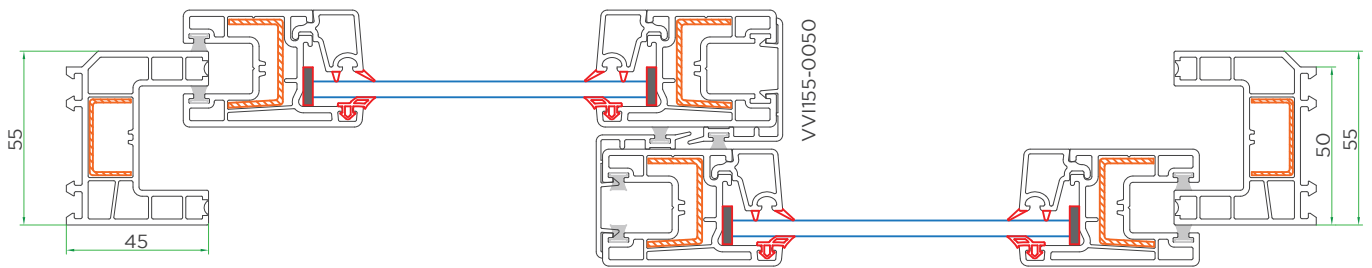

Cross sectional view-2

2.5 Track 2 Panel Sliding Window with Mesh

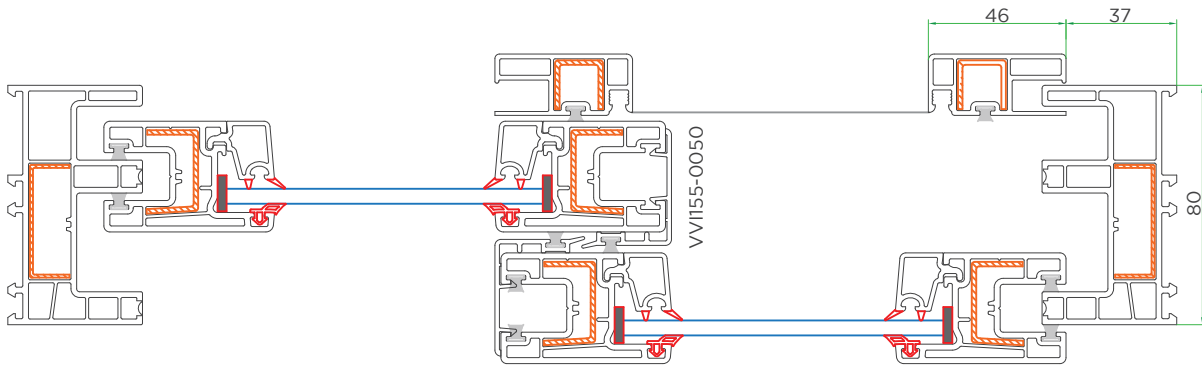
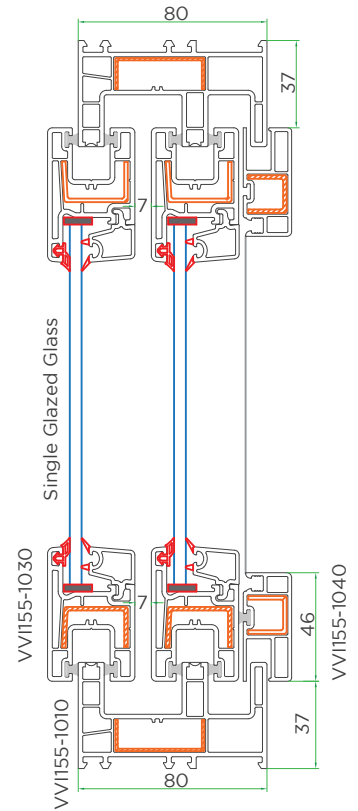
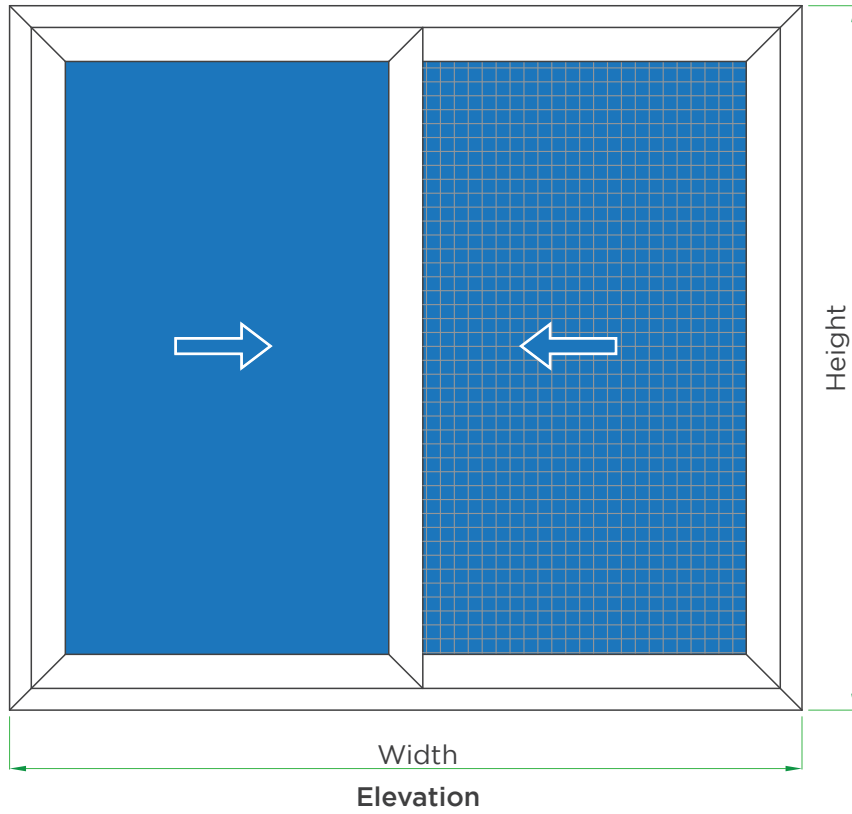

2.5 Track 2 Panel Sliding Window with Mesh

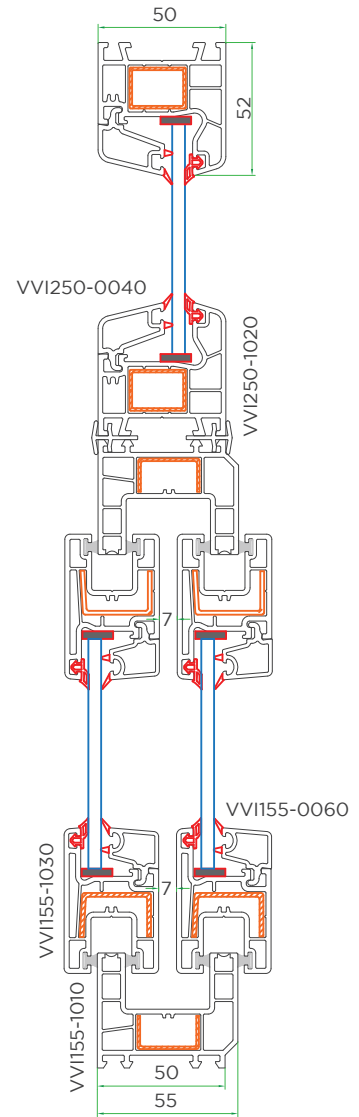
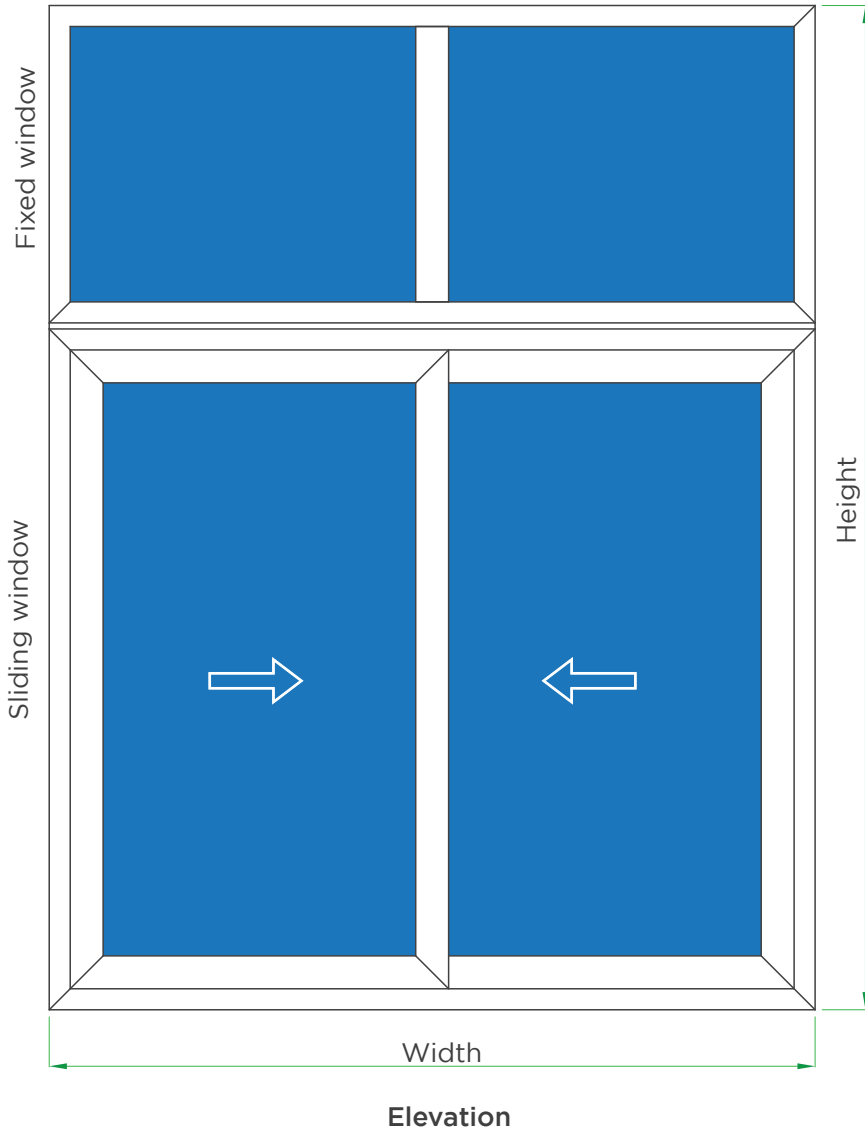

Cross sectional view-1

INTACT PRAGMA

Single Panel Casement Window

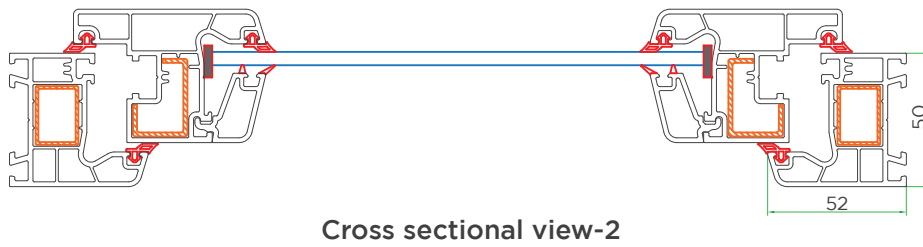
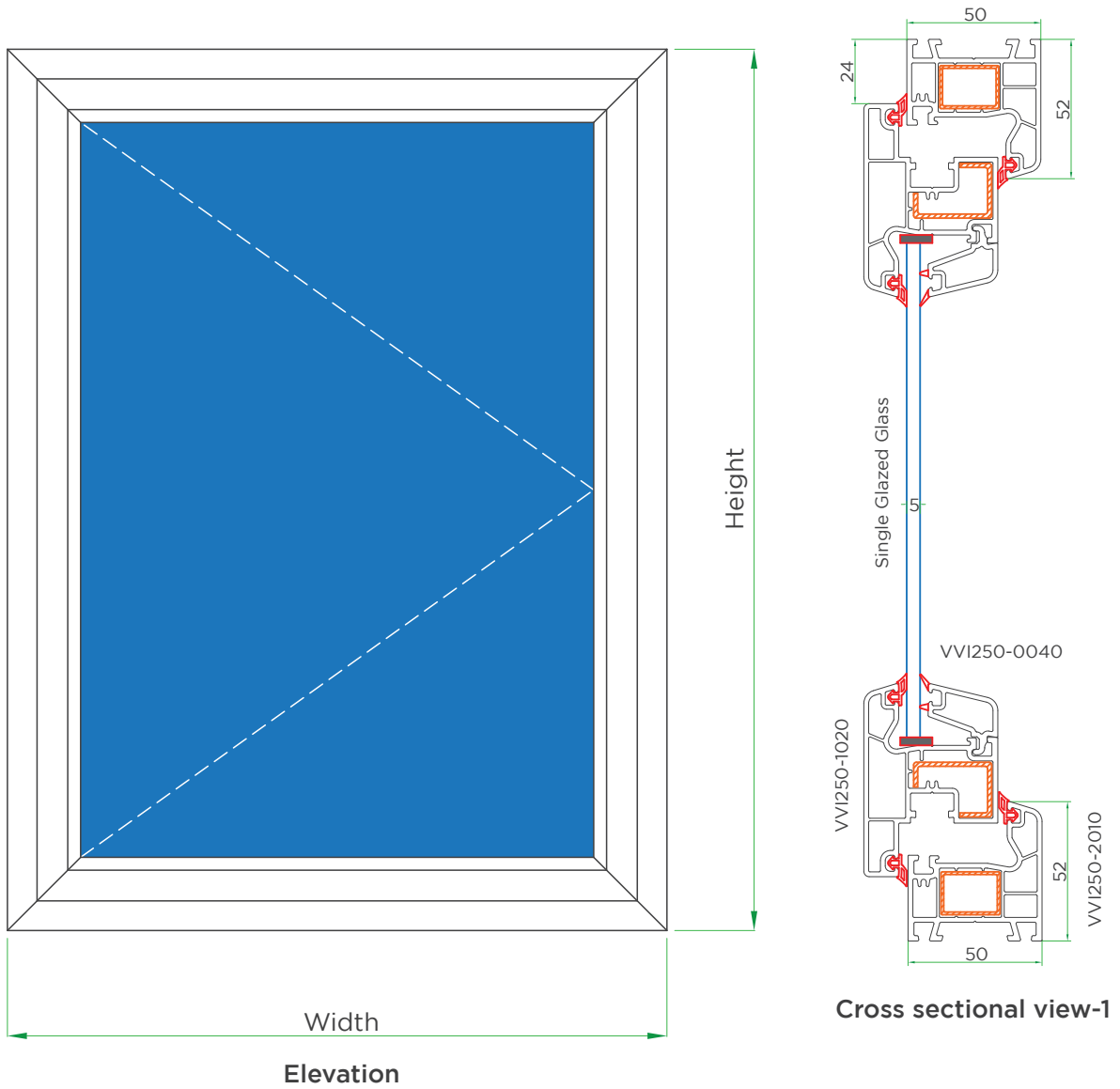

INTACT PRAGMA

Double Panel Casement Window

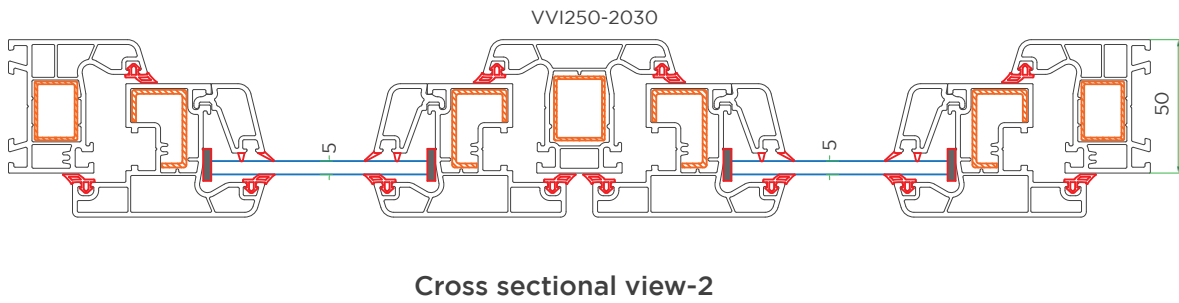
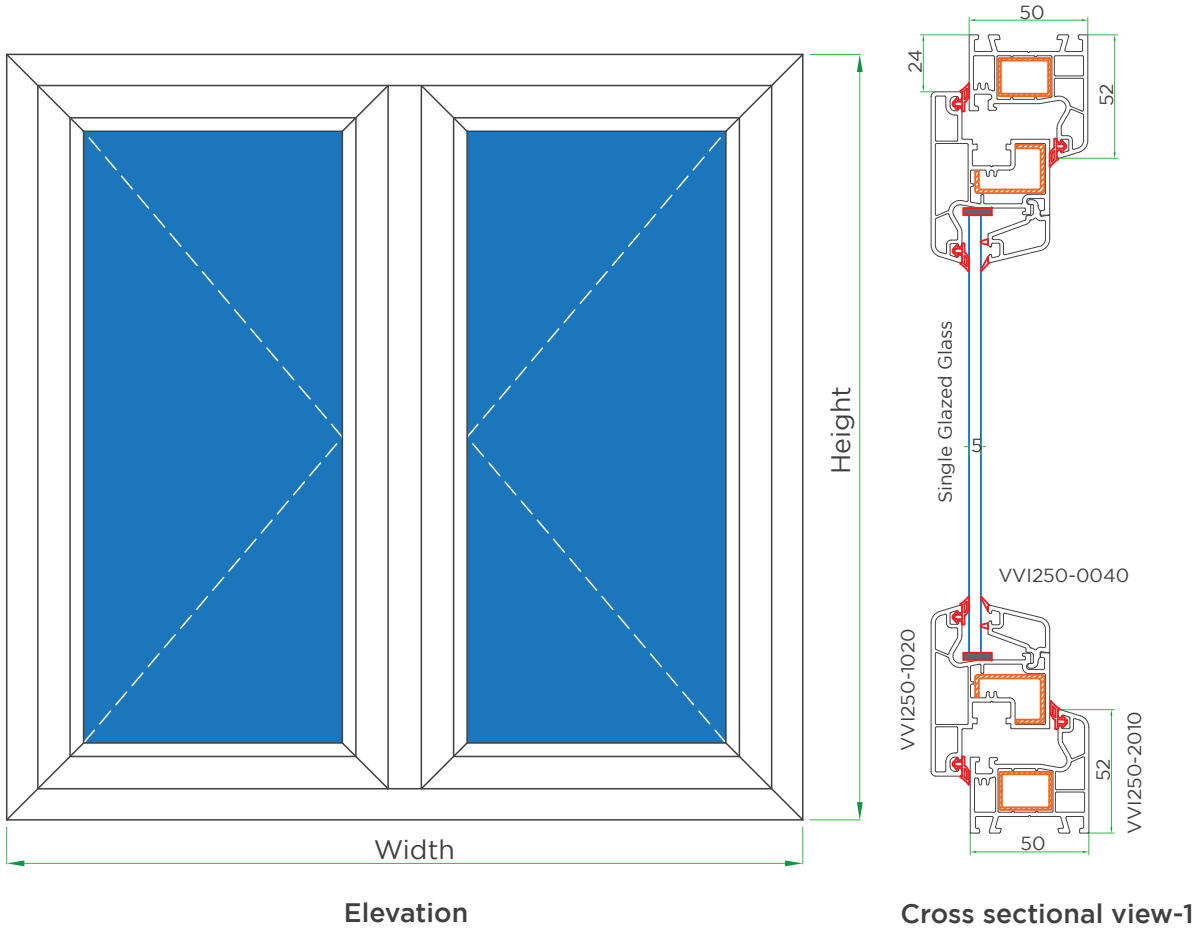

INTACT PRAGMA

Top Hung Window

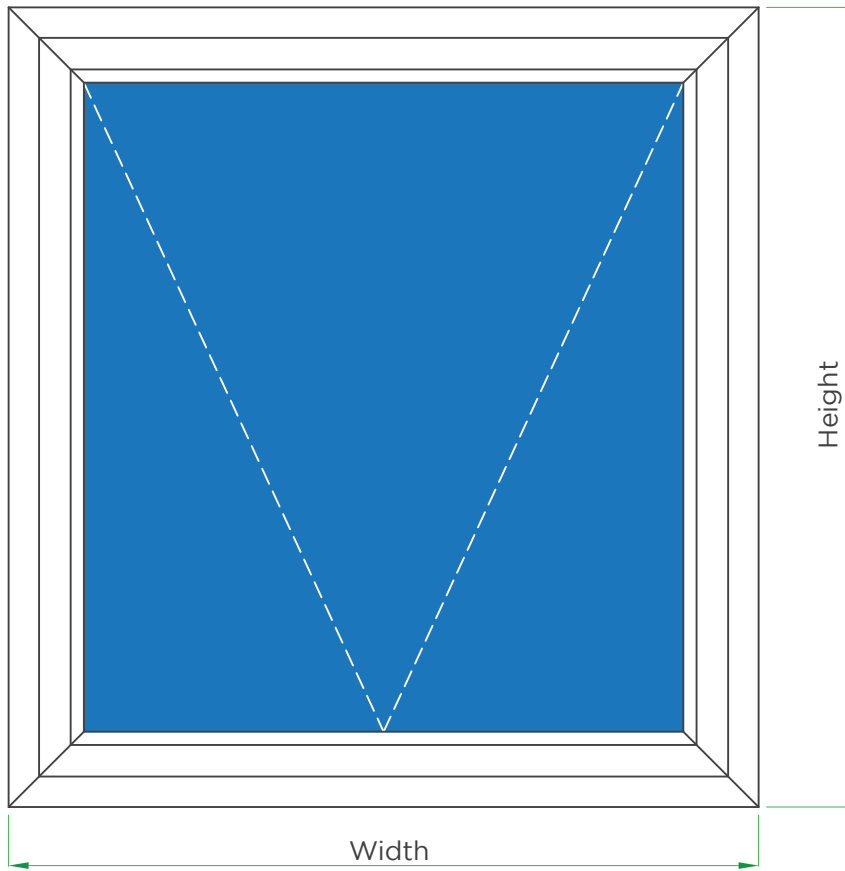

Elevation

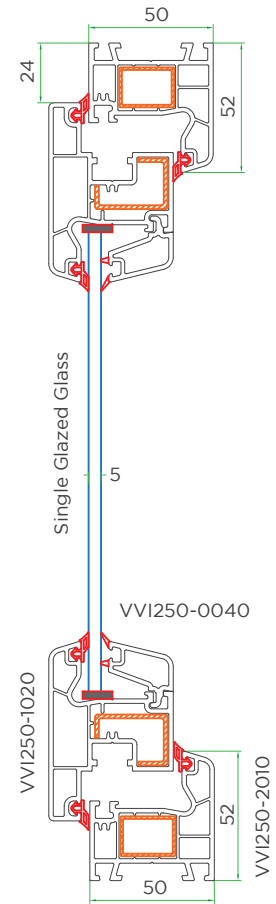

Cross sectional view-1



Cross sectional view-2

Reinforcement

INTACT ULTIMA Sliding series

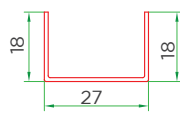
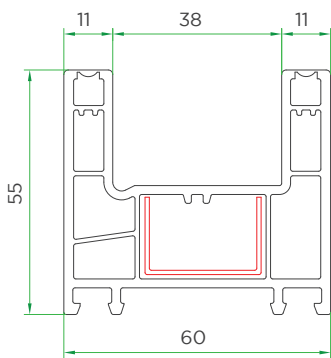

2-track Rein
6001-1001

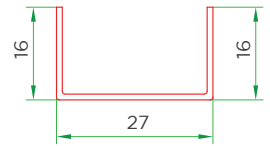
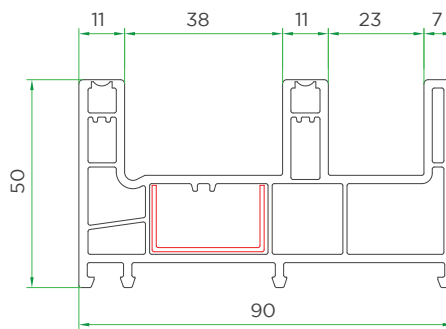

2.5-track Rein
6001-1002

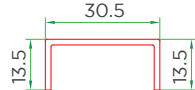
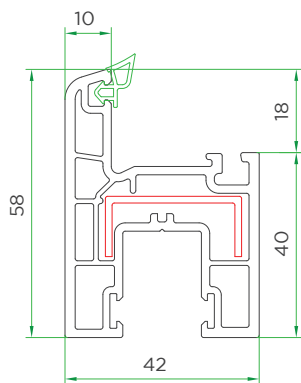

Sash Rein
6001-1503

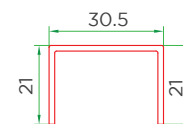
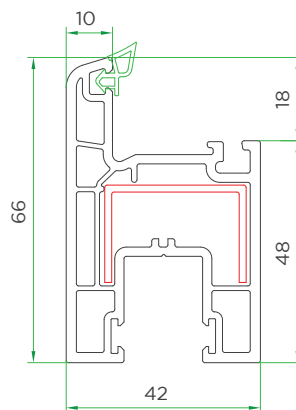

Door sash Rein
6001-1504

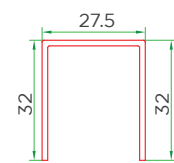
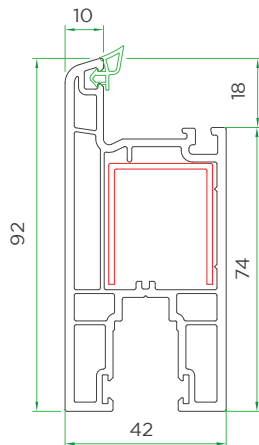

Big door sash Rein
6001-1504

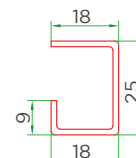
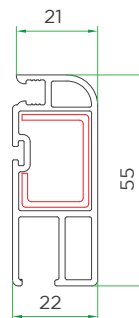

Mesh sash Rein
6001-1505

INTACT ULTIMA Casement Series

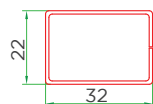
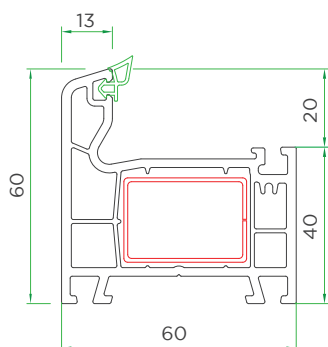

Frame Rein
6002-1001

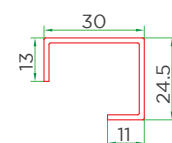
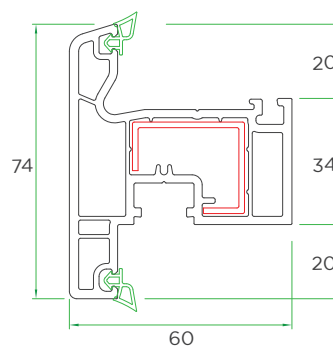

Sash Rein
6002-1502

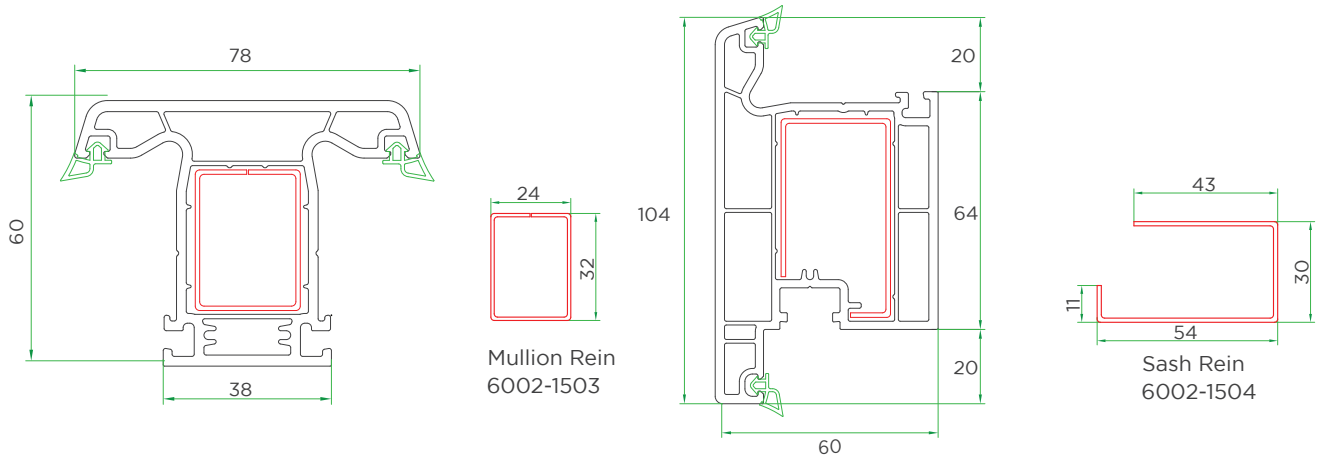

INTACT PRAGMA Sliding series

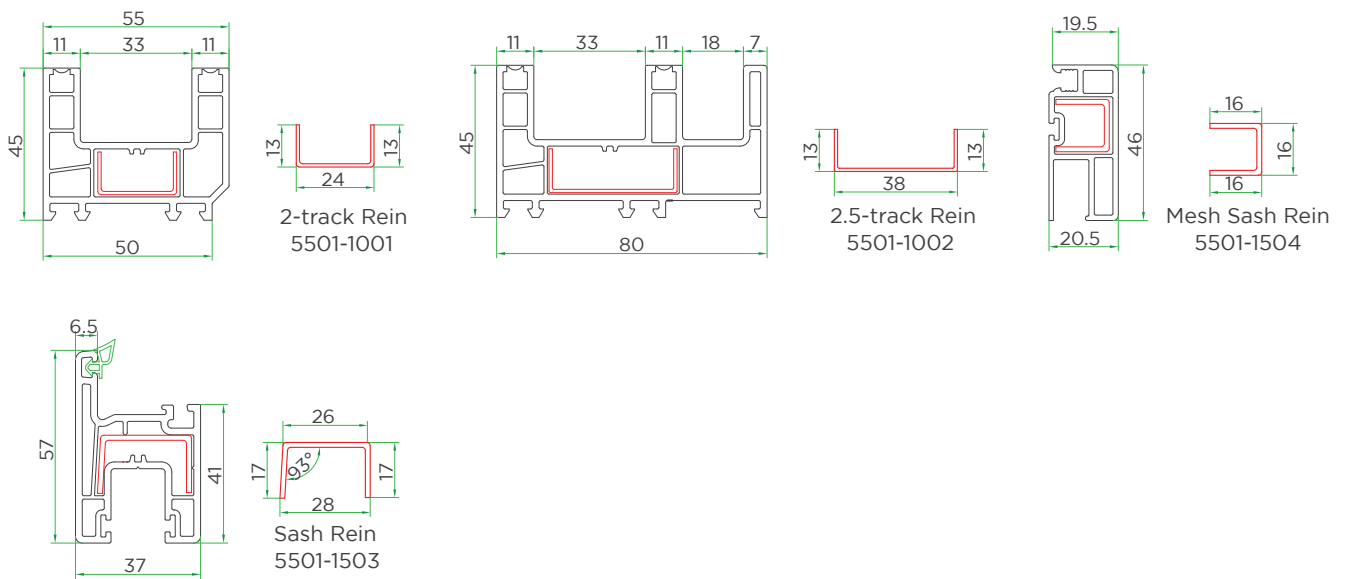

INTACT PRAGMA Casement series

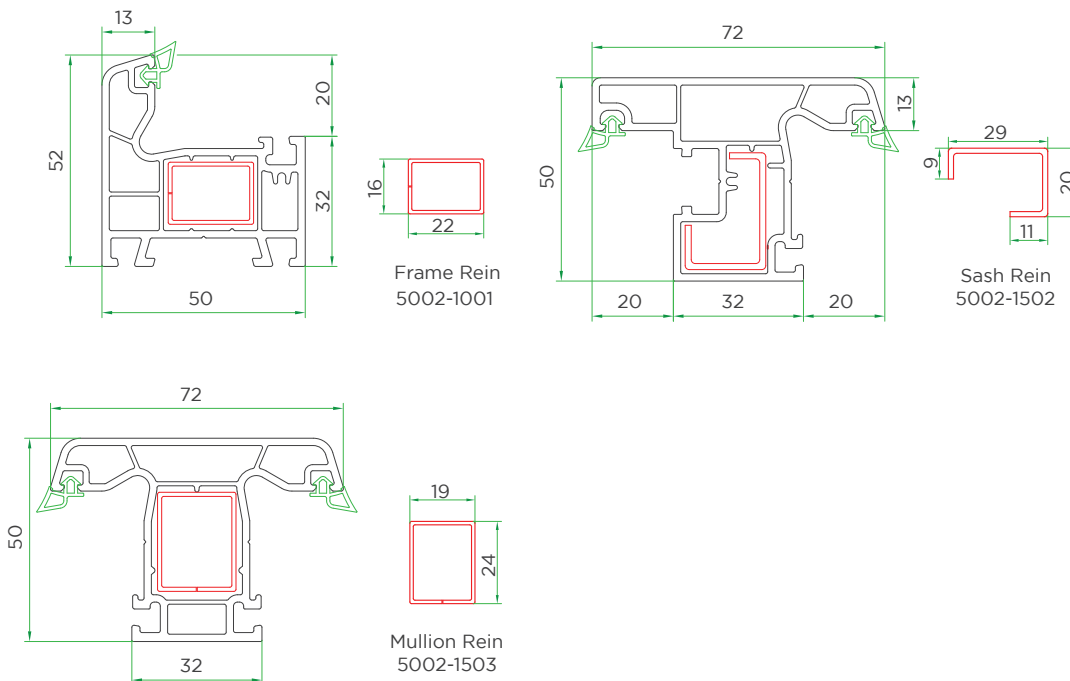



Certifications & Credentials

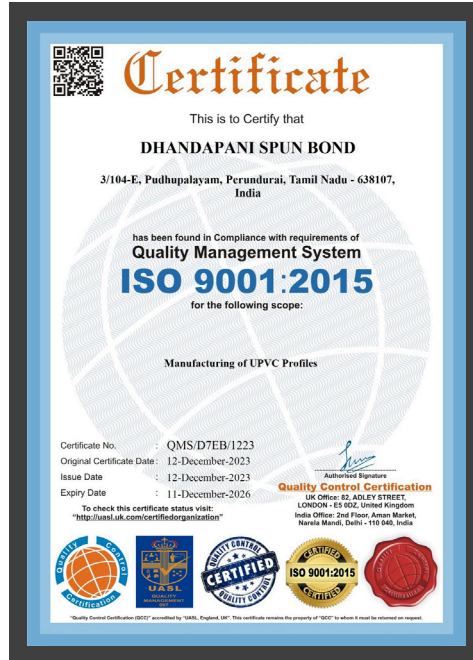

ISO 9001:2015

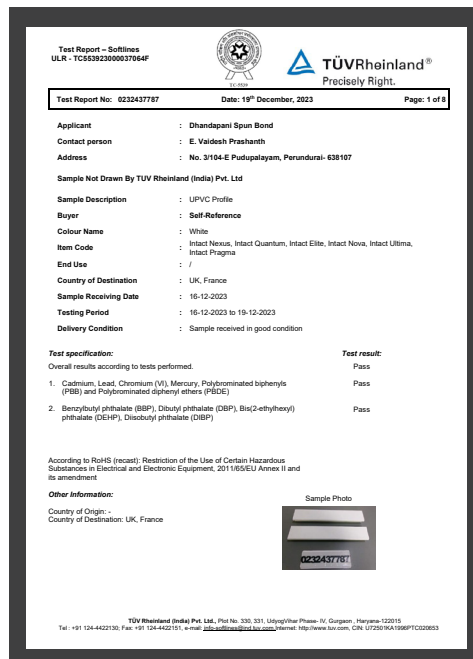

TUV Rheinland

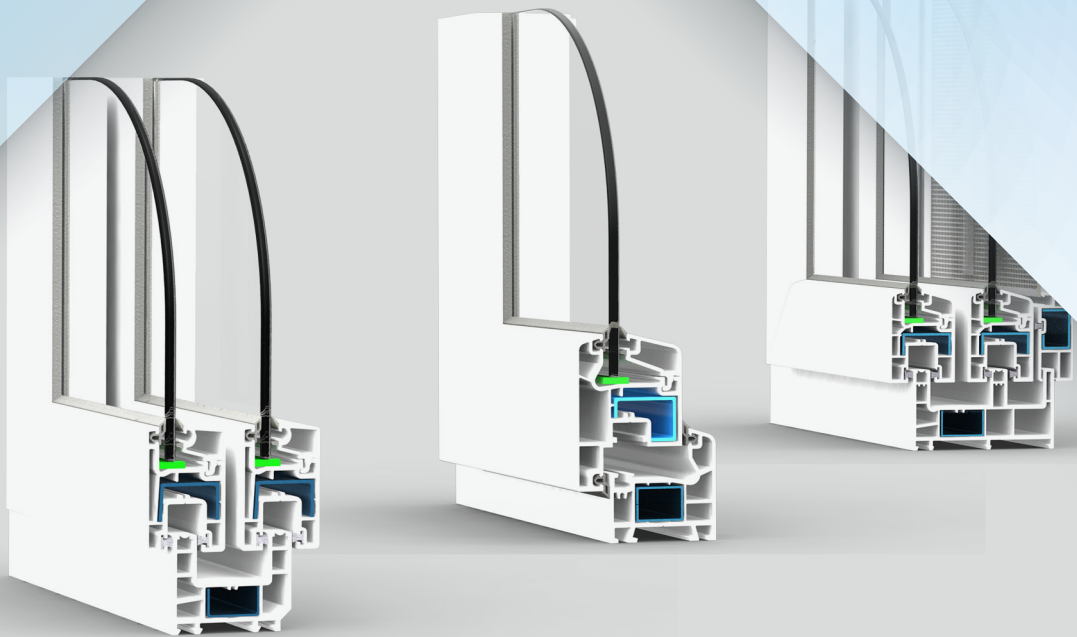

Where Precision Meets Elegance

Dhandapani Spun Bond
104-E, Pudhupalayam, Nasiyanur, Tamil Nadu 638107
M: +91 89256 94646 | E: info@intactupvc.com